



MSU Graduate Theses

Summer 2021

Characterization of Lamellar Liquid Crystal Emulsifiers in Topical Creams Containing a Novel Solvent

Melinda Joanna Sutton

Missouri State University, Sutton17@live.missouristate.edu

As with any intellectual project, the content and views expressed in this thesis may be considered objectionable by some readers. However, this student-scholar's work has been judged to have academic value by the student's thesis committee members trained in the discipline. The content and views expressed in this thesis are those of the student-scholar and are not endorsed by Missouri State University, its Graduate College, or its employees.

Follow this and additional works at: <https://bearworks.missouristate.edu/theses>

 Part of the [Dermatology Commons](#), [Lipids Commons](#), [Materials Chemistry Commons](#), [Medicinal-Pharmaceutical Chemistry Commons](#), [Pharmaceutical Preparations Commons](#), and the [Statistical, Nonlinear, and Soft Matter Physics Commons](#)

Recommended Citation

Sutton, Melinda Joanna, "Characterization of Lamellar Liquid Crystal Emulsifiers in Topical Creams Containing a Novel Solvent" (2021). *MSU Graduate Theses*. 3685.

<https://bearworks.missouristate.edu/theses/3685>

This article or document was made available through BearWorks, the institutional repository of Missouri State University. The work contained in it may be protected by copyright and require permission of the copyright holder for reuse or redistribution.

For more information, please contact [BearWorks@library.missouristate.edu](mailto: BearWorks@library.missouristate.edu).

**CHARACTERIZATION OF LAMELLAR LIQUID CRYSTAL EMULSIFIERS IN
TOPICAL CREAMS CONTAINING A NOVEL SOLVENT**

A Master's Thesis

Presented to

The Graduate College of
Missouri State University

In Partial Fulfillment

Of the Requirements for the Degree
Master of Science, Chemistry

By

Melinda Joanna Sutton

July 2021

Copyright 2021 by Melinda Joanna Sutton

CHARACTERIZATION OF LAMELLAR LIQUID CRYSTAL EMULSIFIERS IN TOPICAL CREAMS CONTAINING A NOVEL SOLVENT

Chemistry

Missouri State University, July 2021

Master of Science

Melinda Joanna Sutton

ABSTRACT

Diethylene glycol monoethyl ether (DEGEE) is a promising solvent component in topical cream formulations due to its superior solubilizing abilities with certain active pharmaceutical ingredients. One of the goals of this study is to characterize the effects of pH on the physical and chemical stabilities of topical cream formulations containing particularly high concentrations of DEGEE by characterizing a full topical pH profile of 3.5 – 9.0. The second goal is to evaluate the presence, amount, and characteristics of lyotropic liquid crystals (LLCs), molecularly structured in a lamellar phase, in a model cream emulsion utilizing polarized light microscopy (PLM). The presence of lamellar structured LLCs has been found to improve the overall character and stability of cream formulations. In this study, it was found that the oil-in-water emulsion is physically stable at pH values under the inflection point. Chemical stability was confirmed by an accelerated temperature condition at 40°C where the pH value was stable throughout the topical profile. The presence and abundance of lamellar LLCs at the oil-water interface were found to be more abundant at pH values below the inflection point. The introduction of thermal studies provided interesting results when lamellar LLCs were heated and slow cooled to ambient conditions. It is possible a different crystalline structure was produced upon cooling the sample; however, continued research is needed to definitively determine these results.

KEYWORDS: oil-in-water, surfactant, crystal, lamellar, polarized, microscopy, birefringence, lyotropic, hot stage

**CHARACTERIZATION OF LAMELLAR LIQUID CRYSTAL EMULSIFIERS IN
TOPICAL CREAMS CONTAINING A NOVEL SOLVENT**

By

Melinda Joanna Sutton

A Master's Thesis
Submitted to the Graduate College
Of Missouri State University
In Partial Fulfillment of the Requirements
For the Degree of Master of Science, Chemistry

July 2021

Approved:

Alan Schick, Ph.D., Thesis Committee Chair

David Osborne, Ph.D., Committee Member

Richard Biagioni, Ph.D., Committee Member

Fei Wang, Ph.D., Committee Member

Julie Masterson, Ph.D., Dean of the Graduate College

In the interest of academic freedom and the principle of free speech, approval of this thesis indicates the format is acceptable and meets the academic criteria for the discipline as determined by the faculty that constitute the thesis committee. The content and views expressed in this thesis are those of the student-scholar and are not endorsed by Missouri State University, its Graduate College, or its employees.

ACKNOWLEDGEMENTS

I would like to thank the following people for their support during the course of my graduate studies. My advisor, Dr. Alan Schick, for assisting me with my thesis project, and coming to my aid with any and all struggles I ran into. Undergraduates: Jenn Nyugen, Carajill Campbell, Lauren Reeding, and Victoria Bax for their long hours in the lab reproducing much of the preliminary work that was needed to verify results.

The MSU Chemistry Department for giving me the opportunity to complete my research and allowing me to use their resources. Dr. David Osborne, for helping me narrow down my research topic, always being available to answer my questions including attached research and articles and supporting me with funding when needed. Independent Derm Solutions, LLC, Dow Development Corporation, Frasier Healthcare (San Diego, CA), and Crodafas for providing funding and chemicals to complete my research.

I dedicate this thesis to my strong, intelligent, and beautiful children Mia, Matelyn, and Rahlow. You three, tirelessly, showed me patience while I strived to balance my duties as an attentive mother and successful student. I heard your grumbles and continued to apply my best while steadily promising you a better future. After seven long years, that future has arrived! With your ongoing patience I was able to complete my associate's, bachelor's, and master's degree, with the latter two degrees being in an arduous field. My loves, we finally made it to the future I had promised during those strenuous years. This dedication, along with my entire thesis, is for you my loves, we did it!

TABLE OF CONTENTS

Chapter I: Introduction	Page 1
A. Human Skin	Page 2
B. Routes of Delivery	Page 5
C. Penetration Enhancers (PE)	Page 9
D. Diethylene Glycol Monoethyl Ether	Page 11
E. Benefits of DEGEE	Page 12
F. Emulsions	Page 17
G. Surfactants	Page 20
H. Lyotropic Liquid Crystals	Page 25
I. Thesis Statement and Purpose	Page 35
Chapter II: Materials and Methods	Page 36
A. Materials	Page 36
B. Methods	Page 37
Chapter III: Results and Discussion	Page 40
A. Physical and Chemical Stability	Page 40
B. PLM Micrograph	Page 43
C. Thermal Study	Page 44
Chapter IV: Conclusion and Future Prospects	Page 48
References	Page 50

LIST OF TABLES

Table 1. Route, dosage, and potency of DEGEE	Page 12
Table 2. Formulation of O/W emulsion containing DEGEE	Page 18
Table 3. Conditions tested for emulsion stability	Page 19
Table 4. Properties monitored during the conditions test	Page 20
Table 5. Changes in the critical packing parameter	Page 29
Table 6. Tabulated data from Figure 23	Page 43

LIST OF FIGURES

Figure 1. Layers of the human skin	Page 3
Figure 2. Intercellular matrix found in the stratum corneum	Page 4
Figure 3. Permeation routes of active ingredients	Page 6
Figure 4. Hydrophilic and hydrophobic pathways of active ingredients	Page 7
Figure 5. Visualization of the flux of an active ingredient	Page 9
Figure 6. Chemical structure of DEGEE	Page 11
Figure 7. Vertical Franz Cell determining permeation of DEGEE	Page 14
Figure 8. Breakdown process in dispersion based on stability	Page 21
Figure 9. Surfactant molecules at two interfaces	Page 22
Figure 10. Surfactant reaction to increased added surfactant	Page 23
Figure 11. Emulsification and the role of a surfactant around droplets	Page 23
Figure 12. Physical properties dependent on surfactant concentration	Page 25
Figure 13. Mesophase change with increased surfactant concentration	Page 26
Figure 14. Geometric representation of a surfactant monomer	Page 27
Figure 15. Schematic drawing of Oleosome and hydrosome	Page 30
Figure 16. Layers of crystalline phase surrounding droplets	Page 31
Figure 17. Potential drop vs distance energy diagram of a droplet	Page 32
Figure 18. Schematic of unpolarized light through birefringent material	Page 33
Figure 19. Trinocular polarized microscope	Page 33
Figure 20. Drawing of Maltese Cross	Page 34
Figure 21. Phase separation during centrifugation	Page 38
Figure 22. pH profile	Page 41
Figure 23. Plot of mass of aqueous phase and pH in ambient and accelerated conditions	Page 42
Figure 24. Microscope images of varied pH values	Page 46
Figure 25. Microscope images of emulsion on a hot plate	Page 47

CHAPTER I: INTRODUCTION

The stratum corneum (SC) is the top layer of the skin that creates a barrier to protect us from particles, chemicals, ultraviolet radiation, and other toxins that could enter our bodies and become systemic.¹ Where active pharmaceutical ingredient (API) delivery is concerned, however, the skin has become another option for delivering APIs. Transdermal delivery has been found to be a safer and preferred route of delivery, compared to oral and parenteral delivery, for specific APIs. The barrier of the SC must be manipulated in such a way that targeted molecules can pass through the skin transdermally but also allow the SC to return to its original characteristics. One way to penetrate the barrier is using specific solvents that interact with the lipids and proteins of the SC. Another way to improve the permeation of molecules is adding a penetration enhancer or modifier to improve the number of actives diffused into the skin.

Diethylene glycol monoethyl ether (DEGEE) is a novel solvent with properties that make it a preferred choice in dermatology and pharmaceutical products. The solvent has been reported to improve permeation and the thermodynamic activity of an API.^{2,3} It has also been known to create an intracutaneous depot with specific actives and interact with the bilayer of API loaded vesicles to improve their permeation through the skin and ultimately deliver the active deeper through the skin layers.^{4,5} Toxicology and carcinogen tests were performed, and it was found to have no hazards, and that 99.9+% pharmaceutical grade is safe and well tolerated on the skin.⁶ In industry DEGEE is used in a range of 5-40%.⁷ In fact, this solvent has recently been FDA-approved to a composition of 49.75%.⁶

DEGEE is both water miscible and a good solvent for hydrophobic materials such as skin oils.⁸ More than 25 % DEGEE formulated into a topical cream improves the skin feel like

moisturization when applied to portions of the skin that are rich in sebum (*e.g.*, oily substance secreted from sebaceous glands that improve the skin's moisturization). This characteristic is excellent for those with a skin type of oily to normal.⁶ However, for those with dry skin an oil-in-water formulation is required.⁸ Due to DEGEE's ability to solubilize hydrophobic molecules, it assists in the solubility of the oil phase in the emulsion.

The use of DEGEE at 25% w/w in an emulsion has caused some difficulty with formulation scientists in formulating a stable topical product. Based on a patent completed by Lathrope and Osborne the incorporation of Crodafos CES into an oil-in-water emulsion containing a high volume of DEGEE was found to be stable at a wide pH range.⁷ Crodafos CES, marketed by Croda, is an anionic emulsifying wax blend of ceteth-10 phosphate, dicetyl phosphate, and cetearyl alcohol.⁸ This surfactant can produce liquid crystals at the oil-water (O/W) interface which has been found to improve the overall stability, moisture retention, controlled-release of active, and the ability to encapsulate targeted molecules in an emulsion.^{2,9}

In this study, an oil-in-water emulsion is formulated utilizing 25% DEGEE and Crodafos CES at a pH range 3.5 – 9.0. Polarized light microscopy is used to analyze and characterize liquid crystals present at the O/W interface in the emulsion. The pH effect on the physical stability was determined by a shelf-life study as well as its chemical stability confirmed by an accelerated temperature condition at 40°C.

A. Human Skin

The human skin is composed of layers: epidermis which contains the viable epidermis, dermis, and the hypodermis (*i.e.*, subcutaneous tissues) which can be seen in Figure 1.¹⁰

The outermost layer of the skin, epidermis, is composed of the SC (*i.e.*, nonviable epidermis)

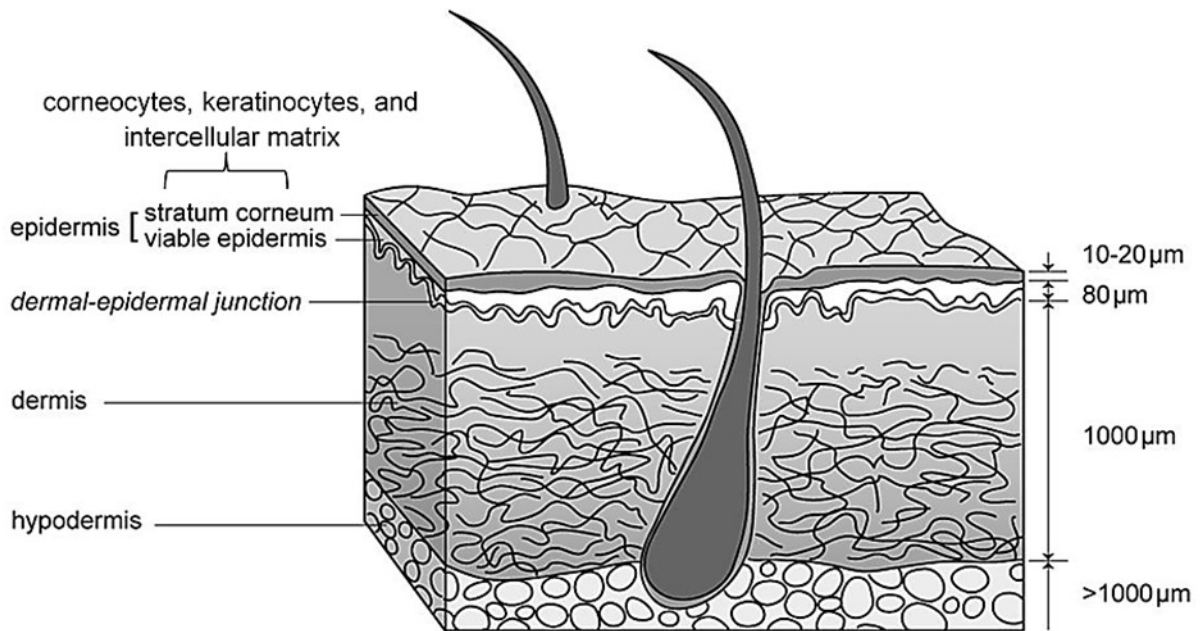

Figure 1. Layers of the human skin, specifically referencing the SC (*i.e.*, nonviable epidermis), is the epidermis, dermis, and hypodermis. The SC of the epidermis is composed of corneocytes, keratinocytes, and an intercellular matrix. This layer is the protective barrier of the outermost layer of the skin. Adapted from Ref. 10.

and the viable epidermis. The SC is composed of corneocytes (*i.e.*, enucleated cells), keratinocytes, and an intercellular matrix composed of lipid lamellae layers in an aqueous environment.¹ The corneocytes are elongated, flat, compacted, and dehydrated cells that are a component of the intercellular lipid lamellae layers (Figure 2). The keratinocytes of the epidermis are responsible for the renewal of the skin as well as to synthesize and express many different proteins and lipids by proliferation (*e.g.*, increase cell number), differentiation (*e.g.*, one cell type to another), and keratinization (*e.g.*, cells under the skin are converted to hair and nails).¹¹

Intercellular Matrix. The SC is the protective barrier meant to keep water in and noxious substances out and is approximately 10-15 cells in depth (10-20 μm) with low hydration which is around 10-20% versus 70% found in the viable epidermis.^{12,13}

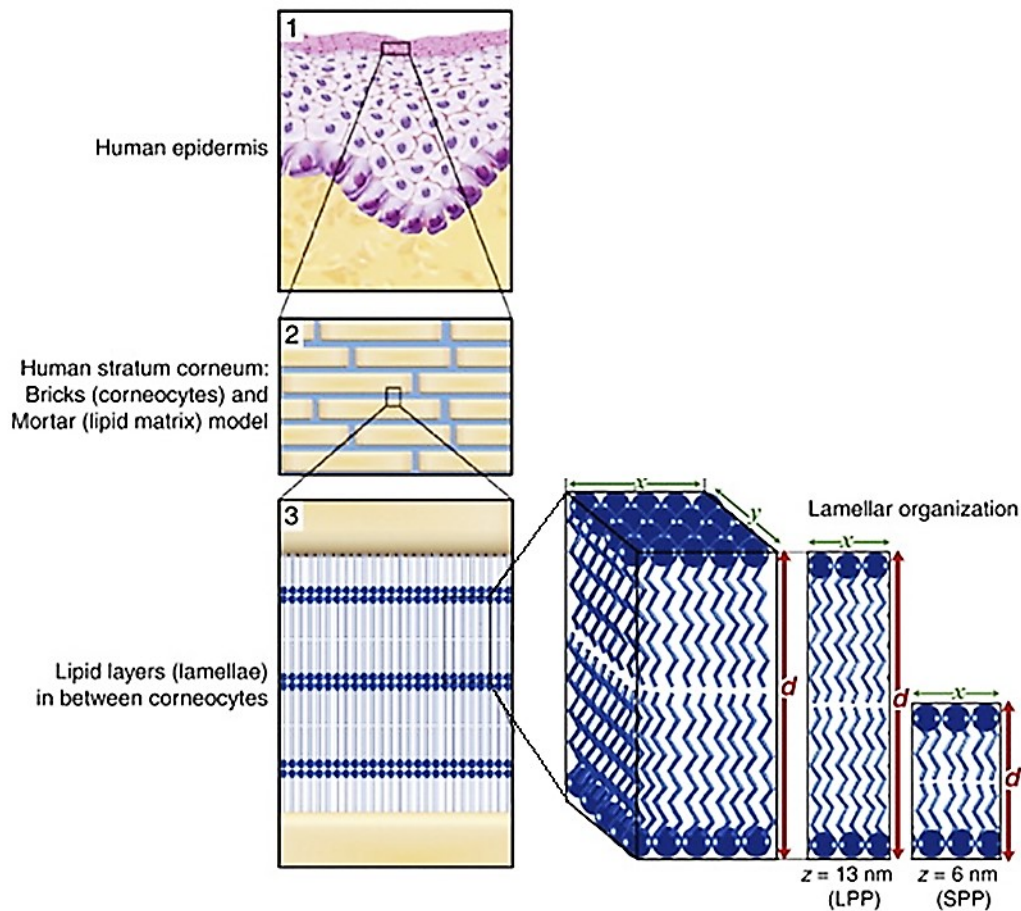

Figure 2. The intercellular matrix (“mortar”), found in the SC, composed of lamellae lipid layers between the corneocytes (“bricks”). Adapted from Ref. 12.

The SC has been described as a “wall-like” structure (Figure 2) in which the corneocytes represent the “bricks” of the wall that are held together by intercellular lipids, or the “mortar”.¹¹ The intercellular matrix of the SC is composed of lipids stacked in a lamellae fashion and is the critical factor in maintaining the permeability barrier function.¹¹ The major components of the lipids found in the matrix are ceramides (*i.e.*, lipids of the intercellular matrix that maintain the skins moisture), cholesterol, and free fatty acids, with ceramides being the most abundant lipid.¹¹

Hydration. The SC has low hydration which is around 10-20% versus 70% found in the

viable epidermis, and to aid in the hydration of the skin the barrier maintains its hydration from within the body. The hydration is driven by a water gradient between the water-rich tissues and the environment surrounding the outer layer of the skin.¹ Because of the difference in vapor pressure from the environment around the skin and the skin itself, extra care is needed in providing proper hydration to the skin. Why hydration is so important is that it can improve the mobility of the components of the skin, lipids, and proteins, which under dehydrated conditions become more rigid. Skin hydration is important in the ability for improved permeability of active ingredients through its barrier, as well as the increased solubility of APIs and the decrease of the diffusion resistance of the SC.¹ For APIs that are water-insoluble, incorporating a solvent that improves the skin's solubility of hydrophobic active ingredients is key. The barrier properties of the SC and the hydration of the skin are important factors when considering transdermal API delivery.

B. Routes of Delivery

It is preferred that topically administered APIs act cutaneously (*i.e.*, dermal) or percutaneously (*i.e.*, transdermal) into the skin. Three different functions can be targeted when applying an API onto the skin using a topical product:¹³

1. The active may need to remain on the surface of the SC, such as in the cases of insect repellents and cosmetics
2. Dermal permeation into deeper layers of the skin. Permeation of actives into the viable epidermis and the dermis layers of the skin. This can also apply to actives that accumulate in the skin as intracutaneous depots with little to no active flux (*i.e.*, rate of permeation) through the skin¹⁴
3. Systemic action of the active to be delivered via transdermal delivery where local interaction (*e.g.*, intracutaneous depot) is unwanted.

Regarding targeting transdermal delivery there are four routes by which an active can be transported through the skin. Through the pores of the skin including transfollicular (hair follicle), transglandular (oil glands), and transepidermal, which includes transcellular (*i.e.*, through the corneocytes) and intercellular (*i.e.*, around the corneocytes through the lipid matrix), as seen in Figure 3.¹¹

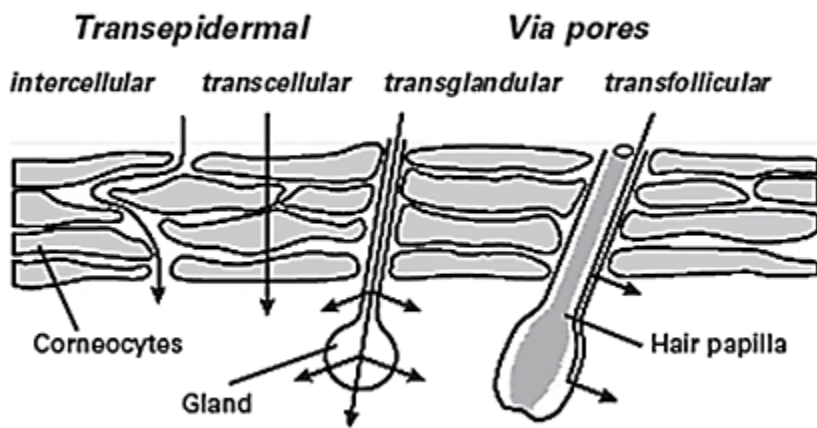

Figure 3. Route options for permeation of APIs through the SC via pores or transepidermal. Transepidermal includes transcellular which is a route through the corneocytes of the SC. Intracellular route goes around the corneocytes and through the lipid lamellae matrix. Reproduced from Ref. 13.

Hydrophilic and Hydrophobic Pathways. The intercellular lipid lamellae matrix exists between the corneocytes, and two pathways within this matrix have been proposed: the hydrophilic and hydrophobic pathways. Figure 4 shows both pathways an active ingredient can permeate through within the SC. In the hydrophilic region there is an aqueous region between the polar head groups of the fatty acids and ceramides. The hydrophobic region is found between the tails of the fatty acids and ceramides.¹¹

Transdermal Delivery. Percutaneous permeation, or transdermal delivery, is the passage of an API into the SC (*i.e.*, the outer layer of the epidermis) by the concentration gradient and its

diffusion through the viable epidermis, which then can go through the dermis and, with appropriate properties, into systemic circulation.¹⁵ It is important to note that most APIs are

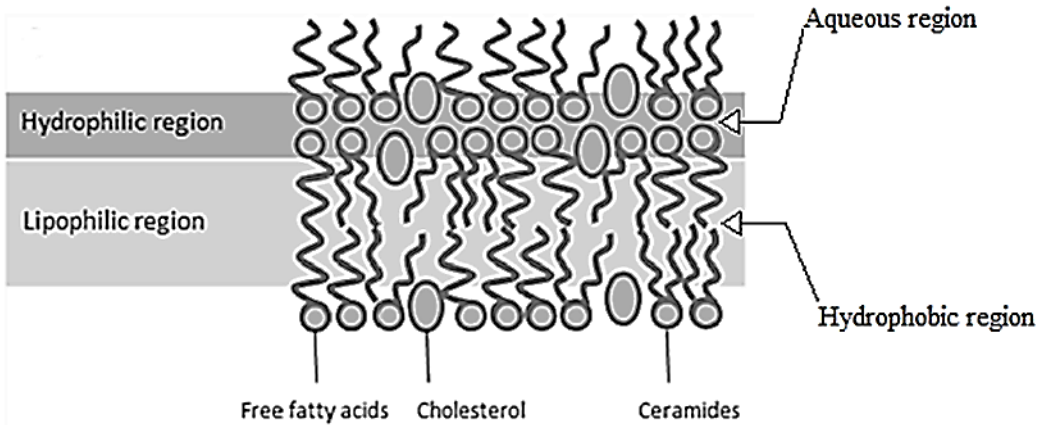

Figure 4. Schematic representation of the intercellular matrix of the SC. There are two different pathways an active ingredient can pass through this matrix: hydrophilic and/or hydrophobic pathway. Adapted from Ref. 11.

Unable to pass through the skin without being combined with a vehicle having appropriate properties (*e.g.*, permeation enhancers, solvents, surfactants). Transdermal delivery can reduce gastrointestinal problems caused by oral delivery, it provides a non-invasive and painless ease of API administration, and it avoids “first-pass metabolism” and rate of absorption issues.³ It also avoids possible infections from other delivery methods like injections.¹¹

The transdermal delivery process begins with the release of the active from the vehicle followed by the permeation into the SC.¹¹ The active then diffuses through the SC by either the hydrophobic or hydrophilic pathway which is defined as the rate-determining step based on its diffusivity through this layer.^{11,15} Once through the SC the API can partition into the aqueous environment of the viable epidermis, and if designed to, may be absorbed into the hydrophilic environment through the capillaries of the dermis.¹¹

When formulating a topical product there are four properties that can influence the permeation process and ultimately the therapeutic properties of topical products:¹⁴

1. The physical and chemical properties of the skin (*e.g.*, skin type and condition)
2. The vehicle to deliver active to the skin
3. The physiochemical properties of the active ingredient (hydrophilic, hydrophobic, and particle size)
4. The interaction between the vehicle and the active ingredient (related to the ability to release the active from the vehicle to the surface of the skin)

To increase permeation, one should rely on two main approaches: increasing the SC's permeability, and the driving force of the active.¹¹ An active must have the ability to penetrate the skin and diffuse through the hydrophobic and hydrophilic properties of the SC. If the active is too hydrophilic it will be unable to detach from the vehicle to the SC. It also cannot be too lipophilic which will cause it to be reserved in the intercellular lipids of the SC. The active would also need to be non-ionized for diffusion across the SC; an ionized active has a lower permeability coefficient.¹¹

Active Permeation. An active's solubility and diffusivity properties establish the rate determining steps previously mentioned. The active's solubility determines the rate at which the active is released from the vehicle and into the SC. The diffusivity determines the speed at which the active propagates through each environment, which depends on such parameters as diffusion path length and viscosity.¹¹ The diffusivity property is defined in terms of the flux of the active ingredient across a barrier (*e.g.*, SC). The flux J is defined as the quotient mass that passes through a specific cross-sectional area over a period of time, $J = \frac{m}{At}$, as illustrated in Figure 5.¹⁶

There are two potential ways to increase the flux of an active ingredient at a constant diffusional pathlength h based on the steady-state form of Fick's first law (Equation 1); increase

the diffusion coefficient D and increase the concentration of the active to increase its driving force C_0 , which can all be improved by a specific solvent, and co-solvents other than water.¹¹

$$J = \frac{dQ}{dt} = \frac{DKC_0}{h} \quad (1)$$

where K represents the partition coefficient of the vehicle, and Q is the amount of active ingredient permeating a given area of the skin.¹¹

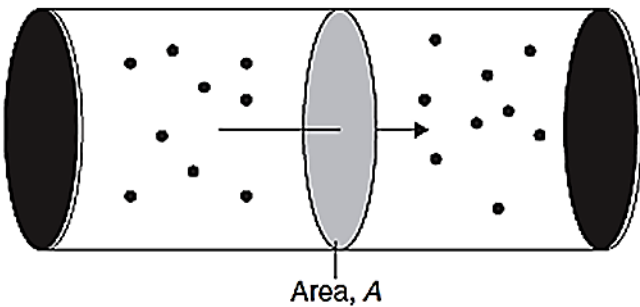

Figure 5. Schematic representation of molecules passing through a cross-sectional area which visually represents the flux of an active ingredient. Reproduced from Ref. 16.

C. Penetration Enhancers (PE)

Enhancement of penetration and permeation of an active can be done physically, chemically, or by use of a formulation product.¹³ The use of a chemical enhancement to improve the permeability of an active is to incorporate a chemical penetration enhancer, or permeability enhancer. A penetration enhancer (PE) is an inactive vehicle that interacts with the SC in a reversible way to aid in the penetration and permeation of an active ingredient.^{11,17}

Penetration enhancers create microcavities within the lipid bilayer of the SC homogeneously (*i.e.*, free volume cavities dispersed evenly throughout the lipid bilayer) or heterogeneously (*i.e.*, concentrated “pores” formed in the lipid bilayers creating a least resistant pathway for hydrophobic molecules) allowing free volume for API diffusion.¹⁷ They rely on the

lipid-protein-partitioning (LPP) theory of skin penetration enhancement, which indirectly increases the thermodynamic activity of the vehicle or increases the solubility characteristics of an active in the formulation.¹¹ Barry (1991) proposed the LPP theory that describes the possible mechanisms on how penetration enhancers alter the SC for permeation of the skin. The LPP theory suggests three possible mechanisms: lipid modification, protein modification, and permeation promotion.¹⁸

Under lipid modification the penetration enhancers are believed to interact with the lipid bilayer of the SC at three main sites: interacting with the polar head groups, aqueous domain of the lipid bilayer, and interacting with the lipid alkyl chain.¹⁷ When an enhancer interacts with the polar head groups by forming hydrogen bonds causes a disruption of the “hydration spheres” of the polar head groups. This disrupts the packing order of the lipid bilayer making the lipids more fluid and increases the volume of the water within the planes of the bilayer which decreases the resistance of the APIs diffusion.¹⁷ The interaction with the lipid alkyl chains increases the lipids fluidization when the penetration enhancer inserts itself between the hydrophobic tails of the lipids in the bilayer. This disruption of the packing order increases the active’s diffusion through the SC.¹⁷

When the penetration enhancer interacts and binds with the keratin filaments found in the corneocytes its defined as protein modification (*i.e.*, interaction with intracellular protein of the SC, intracellular route) under the LPP theory. The interaction denatures the keratin and causes a conformational change of the protein creating vacuoles for active diffusion, by swelling and increasing the hydration of the SC.¹⁷

During permeation promotion (*i.e.*, increasing permeation of an active) certain solvents (*e.g.*, ethanol, DEGEE, propylene glycol) can interact with the aqueous domain of the lipid

bilayers, penetrate the SC, and change its chemical properties (*i.e.*, solubility properties) which allows for an increase in actives diffusion into the SC.¹⁷ This interaction increases the solubility within the SC by matching the solubility parameter of the skin to the API allowing for an increased partitioning of the active from the vehicle into the SC.¹⁷ Lipid modification and permeation promotion are the two mechanisms that have been found to be characteristic of the novel solvent DEGEE.

D. Diethylene Glycol Monoethyl Ether

Transcutol is the tradename for the official United States pharmacopeia name, diethylene glycol monoethyl ether, or DEGEE for short.⁶ It may also be listed as ethoxydiglycol in an ingredient list in agreement with the international nomenclature of cosmetic ingredients (INCI) dictionary.⁶ The use of DEGEE in topical products has increased recently due to its ability to solubilize active ingredients that are insoluble in common solvents. DEGEE can be utilized at a safe concentration at an amount that avoids irritation issues.¹⁹ However, it can also promote the transfer of skin irritant excipients that are formulated in topical products.¹⁷ DEGEE is formed by the ethoxylation of ethanol, and its structure can be seen in Figure 6.

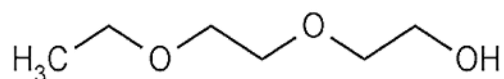

Figure 6. Chemical structure of diethylene glycol monoethyl ether (CAS No. 111-90-0)

Toxicology. Toxicology reports on DEGEE performed by Hardin²⁰ analyzed the material at a 98% purity level, which was found to have adverse effects on rat species when ingested. Ingesting DEGEE caused male rat infertility and testicular atrophy²⁰. Thus, prior to the 1990's

DEGEE was found to be highly toxic. These toxicity affects were most likely caused by the ethylene glycol impurity in the lower grade versions available.¹⁹ Now the USP-NF (United State Pharmacopeia and National Formulary) grades of DEGEE are >99.9% in purity and have been found to give negative results in genotoxicity testing both, *in vitro* and *in vivo*.^{11,19}

Routes of Use. Table 1 lists the solvent's current percent compositions found in various types of product formulations, according to the IID database on the Federal Drug Administration (FDA) website.²¹ As seen in the list; the FDA has approved the use of DEGEE up to 49.91 % (w/w) in a topical gel formulation.

Table 1. Route, dosage, and potency of DEGEE. Information provided by the FDA (updated as of April 12, 2019)*

Route	Dosage form	Potency/amount (unit)
Topical	Cream	15 (%w/w)
Topical	Emulsion, Cream	15 (%w/w)
Topical	Gel	49.91 (%w/w)
Topical	Lotion	1 (%w/w)
Transdermal	Gel	5 (%)
Transdermal	Patch	430 (mg)

*Retrieved from Ref. 21.

E. Benefits of DEGEE

DEGEE has been found to improve the permeation of APIs through the SC, improve the solubility of the active, create intracutaneous depots in the layers of the skin, as well as other attractive properties mentioned below.

Inhibits Proliferation. In a study completed by Levi-Schaffer and co-workers²² found DEGEE inhibits proliferation towards skin diseases. This characteristic was found by studying human normal and psoriatic dermal fibroblasts that were donated from volunteers. 3T3 Swiss albino mouse and human fibroblasts were cultured and incubated in several different compounds, including DEGEE. Murine lymphoma cell line YAC and murine mastocytoma cell line P-815 were also assayed for viability and numbers for fibroblasts. It was found that DEGEE increases the inhibition of rapid cell production and was highly effective in inhibiting proliferation of P-815 tumor cells and it was not cytotoxic.²²

Improved Permeation. Gannu and co-workers³ found that DEGEE improved the permeation of an active and the potential of the solvent to be a vehicle for transdermal delivery. They completed their study *in vitro* by using porcine skin and a Franz diffusion cell. The mechanism of permeation by DEGEE was theorized to compete with the hydrogen bonding of terpenes with the ceramide head groups in the lipid lamellar bilayer matrix. It is possible that the interaction breaks the lamellar hydrogen bonds within the bilayer matrix of the SC, causing a new polar pathway of channels.³

Improved Thermodynamic Activity. During a modified vertical Franz diffusion cell (Figure 7) study utilizing whole and stripped dorsal male rat skin, Ganem-Quintanar and co-workers² evaluated the rate of DEGEE-water interchange. An experiment in which the inflow of DEGEE and outflow of water were measured in a uniform distribution across the donor, skin, and receptor compartments of the cell was completed. Before permeation DEGEE was placed in the donor compartment, water in the receptor, and pig skin between each compartment.

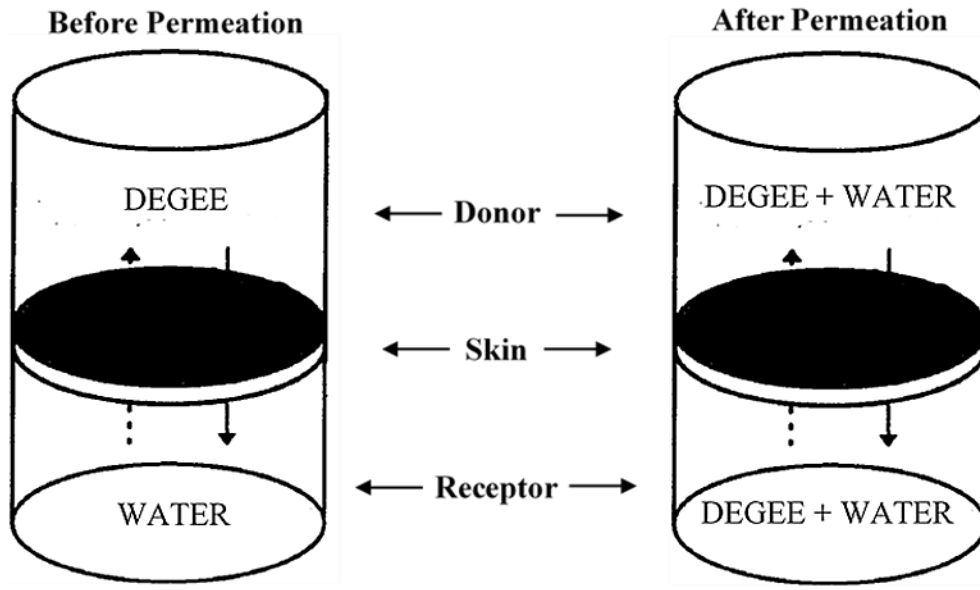

Figure 7. Schematic representation of a vertical Franz Cell. Before permeation DEGEE is found in the donor compartment. After permeation DEGEE + Water is found in both donor and receptor compartments. Adapted from Ref. 2.

After permeation, DEGEE was found in the receptor compartment, which indicates that the solvent does pass through the skin. Water was found in the donor compartment which influences the API's solubility by improving the skin's hydration which improves the thermodynamic activity (*i.e.*, the potential of the active to be released from the vehicle to the skin) of the active. The transfer of water to the donor was likely due to DEGEE's hygroscopic properties (*i.e.*, absorb moisture from the air). The inflow of DEGEE and outflow of water across all compartments improved the moisturization of the skin and influenced the active's solubility. It is possible that DEGEE alters the barrier properties of skin by substituting for water molecules in the SC and thereby affecting the active's ability to penetrate.²

Intracutaneous Depot. Ritschel and co-workers⁵ found that that DEGEE decreased the permeation of an active across the skin but increased the penetration of the active into the skin, which shows promise for targeting specific actives into the skin. They completed their study

using the actives, dexamethasone, and hydrocortisone. DEGEE was formulated into a gel and was evaluated *in vivo* using rats. They observed the binding of the active to the skin in both full thickness (epidermis + dermis) and full epidermis with the dermis removed (epidermis + SC) samples. Their results showed that the amount of both actives bound to the skin was similar in the full thickness and epidermis + SC samples (*e.g.*, amount of API, $\mu\text{g}/\text{mg}$ in the presence of 50% DEGEE). This would mean that an intracutaneous depot of active is found in the epidermis + SC. During the autoradiography review they found that hydrocortisone was uniformly distributed in the skin in the presence of DEGEE versus localization of the active in the epidermis and hair follicle only when not treated with DEGEE.⁵

A similar study by Otto and co-workers²³ observed that DEGEE increased the skin's retention of the hydrophobic APIs, dexamethasone, and hydrocortisone. The permeability by transdermal delivery decreased, which indicates an intracutaneous depot. This was based on the knowledge that the addition of a penetration enhancer (PE) in a topical formulation or directly on the skin can determine the driving force for diffusion across the skin. Solubility of the active by the PE in the formulation increased which coincidentally reduces the penetration through the skin due to the active's affinity for the vehicle. For this reason, the solubility of an active ingredient needs to be compensated for the addition of the penetration enhancer so that the maximum thermodynamic activity of the active can be achieved while reducing the attraction between the active and vehicle.

Vesicle Deformability. A study completed by Manconi and co-workers⁴ described DEGEE as an “edge activator”, which improved the deformability of vesicles by interrupting the phospholipid packing in its bilayer causing it to become more elastic. This is important due to the vesicle's ability to squeeze through a small pore as a result of its bilayers becoming

deformed. DEGEE was found to create an intracutaneous depot of the active-loaded vesicles which allowed the vesicles to reach the epidermis, and then could travel independently deeper into the layers of the skin. This was found by preparing vesicles, liposomes, and penetration enhancement vehicles (PEVs), both empty (control) and active-loaded (diclofenac). High performance liquid chromatography was utilized to verify the amount of active loaded in each vesicle, and the deformability of vesicles were carried out by the extrusion method (*e.g.*, reducing the vesicle from multilamellar to unilamellar by passing them through a membrane filter). Skin permeation studies were completed *ex vivo* by Frans Diffusion vertical cell analysis utilizing newborn pig skin.⁴ It was found that PEVs in the presence of DEGEE always showed a smaller vesicle with a more negative zeta potential for both empty and loaded vesicles compared to PEVs without DEGEE. A more negative zeta potential tends to prevent the aggregation and fusion of vesicles, which indicates better stability.⁴

Manconi and co-workers hypothesized that DEGEE interacts with the initial portion (*i.e.*, outside layer of the vesicle) of the hydrophobic tails of the vesicle rather than deep into its bilayers, because of steric hinderance between its polar headgroup and short hydrophobic chain. This allows the polar head of DEGEE to stick out from the vesicle and interact with the water molecules. Manconi and co-workers observed this characteristic of DEGEE during rheometric studies looking at viscosity variations in vesicles versus temperature change. At specific temperatures, the vesicles transformed from a paracrystalline, gel-state structure to a liquid-crystal structure. With increasing temperatures, the vesicle changed from a low-viscous, rigid gel-state bilayer to a more fluid liquid-state bilayer. The presence of DEGEE decreased the overall transition temperatures of the vesicles, thereby causing an interruption of the

phospholipid characteristics, fluidizing the vesicle's bilayer, and improving permeability of active-loaded vesicles.⁴

Benefits Summarized. It has been found and hypothesized that DEGEE is hyperproliferative towards skin diseases²², improves the moisturization of the skin², and decreases the permeation of an active across the skin while increasing the penetration of the active into the skin.^{15,17} DEGEE interacts with the aqueous domain of the lipid bilayer by matching the solubility of the active to the solubility parameter of the skin, which improves the permeation (partition coefficient) of the active from the vehicle into the SC.^{6,17} DEGEE increases the solubility of the active within the SC, creating an intracutaneous depot and maximizing the active's thermodynamic activity.^{2,6,23} Finally, DEGEE has been determined to be an “edge activator,” improving the deformability of loaded vesicles.⁴

Due to these desirable features of this specific solvent, we have formulated DEGEE into an oil-in-water emulsion. The definition of an emulsion and the types of dispersions for topical use will be discussed.

F. Emulsions

DEGEE, along with other components, was incorporated into an oil-in-water (O/W) emulsion (Table 2). An emulsion is a liquid-liquid dispersion in which large droplets (micron size) of one liquid are suspended in a continuous phase of another.²⁴ Emulsions, microemulsions, and nanoemulsions are three main types of dispersions to consider when formulating a topical product. Each can contain an oil phase, aqueous phase, a stabilizing surfactant (emulsifier), and in some cases a co-surfactant.²⁵

Table 2. Formulation of O/W emulsion containing DEGEE

Ingredient	Tradename	Wt%
<i>Water Phase</i>		
Deionized water		49.75*
1.00 N NaOH (aq)		
<i>Oil Phase</i>		
White Petrolatum USP		10.0
Isopropyl Palmitate	Crodamol IPP	5.0
Emulsifier blend	Crodafos CES	10.0
<i>DEGEE Phase</i>		
Diethylene Glycol Monoethyl Ether	Transcutol P	25.0
Methyl Paraben		0.20
Propyl Paraben		0.05
Total		100

*A specific amount of 1.00 N NaOH (aq) is added to the water phase which is then diluted to a combined total of 49.75 wt % of the total cream formulation.

Stability Testing. The stability of a dispersion is important both during and after formulation. The stability of an emulsion is determined based on the observed changes in particle size, and the droplet density versus the density of the medium in which they are dispersed.²⁶ There are physical and chemical properties that should be tested after the formulation of the topical product before it moves to production. Tables 3 and 4 list the types of properties and test methods used to determine a dispersion's stability. The emulsion tests listed in Table 4 provide information regarding the effects of shipping and storage on the product in its container. The properties monitored during stability testing are vast and it is understood that ideally all property methods should be utilized (Table 4). However, access to all instruments may not be feasible for some formulators. Often pH, viscosity, odor, flow behavior, and separation are the typical physical properties analyzed at room and elevated temperatures.²⁷

Physical Breakdown. If an unstable dispersion is formulated, its shelf-life is limited, and physical breakdown can occur (Figure 8). The center square of Figure 8 represents the emulsion in its homogenized colloidal state. Creaming can occur by gravitational or centrifugal force. For instance, if an external force on the system is greater than the Brownian motion (*i.e.*, thermal motion), separation of the cream into separate phases based on the density will occur. The more phases that separate (*e.g.*, aqueous, oil, solid phase), the more unstable is the emulsion. The denser phases will be found at the bottom of the separated emulsion, whereas the less dense particles will be at the top.²⁶ Creaming by centrifugal force is of interest in this study. As suggested by Friberg and coworkers²⁴, the application of mixed surfactants (*e.g.*, Crodafos) can form a mixed surfactant film that, under the right conditions, will produce multiple bilayers covering the suspended droplets in solution. These multiple bilayers constitute a liquid crystalline phase (*i.e.*, multilayered structures) that lowers the potential drop in the Flocculation process, thereby reducing the van der Waals attraction between droplets.

Table 3. Conditions tested for emulsion stability

Storage Conditions	Storage Period
Ambient temperature	25 °C for 3 yrs
Elevated temperature	37 °C, 45 °C 6 mths
Refrigerator	4 °C 3 mths
Freeze/thaw cycles	5 at -10 °C to ambient
Cycling chamber	4 °C to 45 °C in 48 hrs for 1 month
Light exposure	Light cabinet*

*Light cabinet or 1-month exposure to north-facing light, adapted from Ref. 27.

Table 4. Properties monitored during the conditions test*

Property	Test Method
pH	pH meter
Viscosity	Rotational viscometer
Flow behavior	Oscillatory shear viscosity
Tack/Texture	Extensional and compressional deformation
Color	Visual or colorimeter
Odor	Organoleptic
Specific gravity	Pycnometer
Separation (creaming)	Visual or instrumental
Conductivity	Conductivity meter
Droplet size distribution	Microscopic image analysis and instrumental
Preservation	Microbial challenge and/or assay
Vibration	Shipping test or shaker table
Active ingredient(s)	Chemical or bio-assay
Lyotropic liquid crystal	Polarized light microscopy

*Adapted from Ref. 27.

G. Surfactants

Surfactants have been defined as “surface-active agents” and have the ability to stabilize interfaces in an emulsion and self-assemble into specific structures. Surfactants can stabilize interfaces by lowering interfacial tension between two liquids, a liquid and a gas, and liquid and a solid.²⁶ Surfactants consist of two parts, a hydrophilic (polar) head group and a hydrophobic tail. This allows the compound to have both water-soluble and water-insoluble components and are often utilized in colloidal systems.²⁸

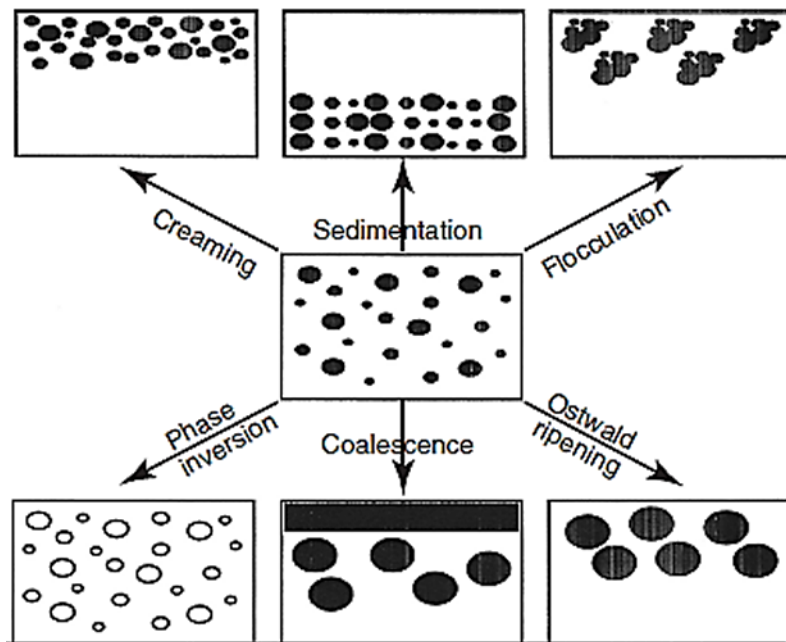

Figure 8. Visual representation of multiple breakdown processes that can occur in dispersion based on its stability. Reproduced from Ref. 26.

There are four classifications of surfactants: anionic, cationic, nonionic, and amphoteric. In this study the surfactant used is an emulsifying wax blend of an anionic surfactant and fatty alcohols (cetearyl alcohol, dicetyl alcohol, and ceteth-10 phosphate) and is marketed by Croda Personal Care (East Yorkshire, UK) under the tradename, Crodafos CES. It presents as a white, waxy solid and is known to form a liquid-crystal-stabilized emulsion that can be formulated at a wide range of pH values.⁸ Anionic surfactants in general are more effective than cationic or nonionic surfactants for increasing the skin permeation characteristics of certain molecules. Anionic surfactants carry a negative charge on the hydrophilic portion of the molecule and interact with the lipid and keratin components of the SC.^{29,30}

Self-Assembly. A characteristic of surfactants is their ability to self-assemble into specific structures (*e.g.*, micelles and lyotropic liquid crystals). Before self-assembly occurs, the surfactant monomers begin to adsorb at the different interfaces and consequently reduces their

interfacial tension.^{30,31} As a surfactant is added to an emulsion the monomers will begin to form a monolayer at the energetically favored air-water (A/W) interface with the hydrophobic tails sticking out into the gas phase (*i.e.*, air) and the hydrophilic heads submerged in the water phase.³¹ This will replace the highly structured hydrogen bonds of the water phase with weaker van der Waals structured hydrocarbons (Figure 9).³¹ Once the A/W interface is completely saturated the free monomers will begin to absorb at the oil-water (O/W) interface. This causes the oil droplets to reduce their size and become more stable. Once all the interfaces are completely saturated the free surfactant monomers are forced to collect in the bulk phase of the solution (Figure 10). Due to the alkyl chains lack of affinity to water it prefers to interact with itself forming entities known as micelles.³² The bulk solute concentration at which micelles begin to form is known as the critical micelle concentration (CMC), and the driving force for the self-assembly process is known as the *hydrophobic effect*.^{31,33}

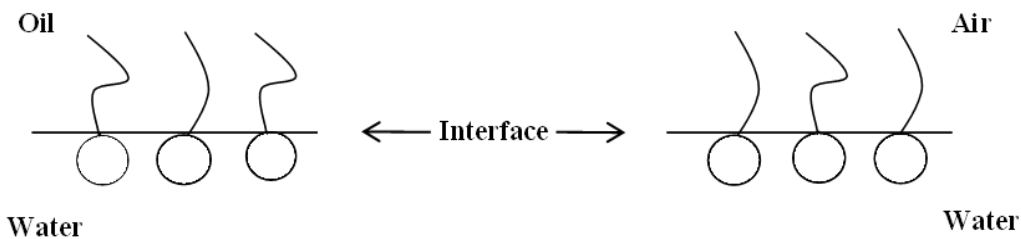

Figure 9. Schematic representation of a surfactant molecule at two simple interfaces. Hydrophobic tail resides in the oil or air phase, and they hydrophilic head resides in the water phase. Reproduced from Ref. 31.

Emulsification. Tadros²⁶ provided a visual representation of the processes that occurs during emulsification and how surfactants play a role at the O/W interface reducing the droplets size in the emulsion (Figure 11). The bold lines and dots around the droplets represent surfactant

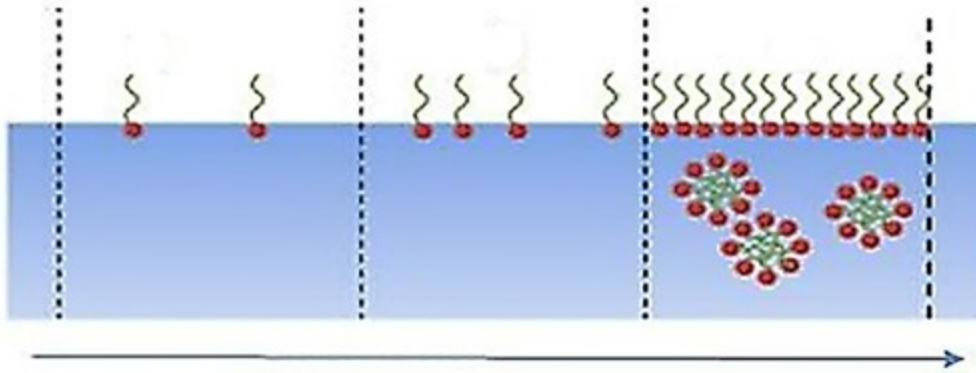

Figure 10. Schematic representation showing a surfactants reaction to the increased concentration of added surfactant molecules to the bulk phase solution. Reproduced from Ref. 29.

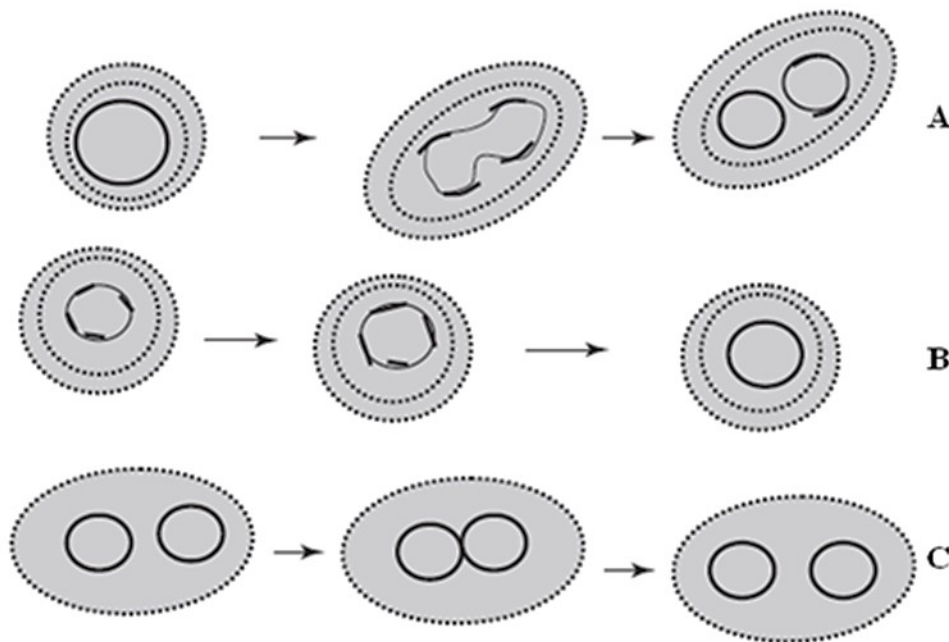

Figure 11. Visual representation during emulsification and the role of a surfactant. Solid lines are the drops, and the surfactants are represented by the thicker lines and dots. A) Emulsification, B) surfactants surround smaller droplets, and C) show surfactant adsorbed droplets collide but do not coalesce. Reproduced from Ref. 26.

Molecules, while the non-bold lines represent the droplets in the emulsion. Process A represents the breakup of a larger droplet into smaller droplets during emulsification. The surfactant molecules surround the drop, lowering the interfacial tension and reducing the stress needed to

break up and reduce the droplet size. During process B the surfactant adsorbs between the oil and water interface of the droplets. The final process C represents the collision of droplets and how the surfactant reduces the chance of coalescence.²⁶

The Hydrophobic Effect. The hydrophobic effect occurs due to the hydrophobic portions of the molecules lack of affinity to water. The affinity of the hydrocarbon to itself is similar to water's affinity for other water molecules.³⁴ This minimizes the interface between the hydrophobic portion of the molecules and the water molecules. The hydrocarbon molecule causes an increase in the degree of structure in the surrounding water molecules.³¹ Even though water has a strong polarity, one important feature of water is its tendency to hydrogen bond. Water therefore rearranges its structure to form cages around the solute. By this action water becomes more ordered, which occurs for smaller solute molecules. If larger solute molecules are present, then the connections (hydrogen bonds) between adjacent water molecules in solution must be broken. If the dissolved solute molecule is unable to form hydrogen bonds with the surrounding water molecules the entropy change for that system is very costly.³²

Critical Micelle Concentration. The CMC is a concentration level between surfactant monomers and water where interacting monomers begin to form aggregates (Figure 12). In this figure, the surface tension is seen to decrease until the surfactant concentration and water ratio reaches the CMC value which then stabilizes. The turbidity (*i.e.*, micelles solubility limit) sharply increases. The increase in turbidity decreases the solutions (*i.e.*, micelles and water) clarity then becoming opaquer, and supports the moment micelles begin to transform into new structures.³⁵ As micelles exist as separate entities in solution and the surfactant concentration is increased repulsive and attractive interactions occur between aggregates (*i.e.*, micelles).

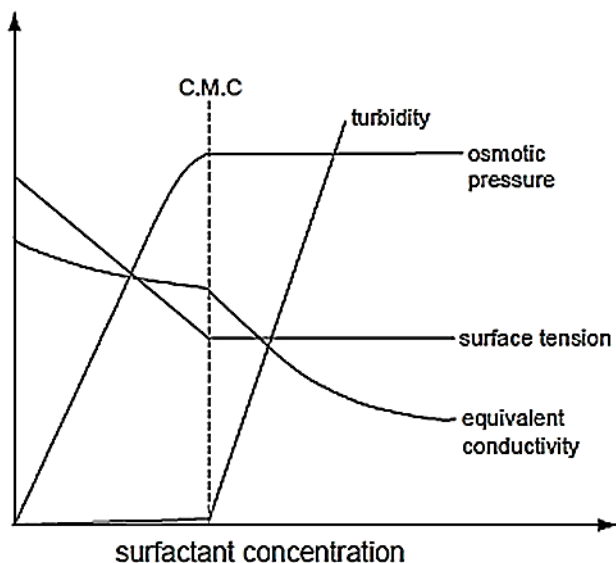

Figure 12. Represents the physical properties that are dependent on concentration of a surfactant that forms micelles. Reproduced from Ref. 33.

The attractive interactions between aggregates causes them to condense into a separate phase from the dilute aqueous solution (*e.g.*, turbidity increases). The repulsive interactions force the aggregates shape to change to create more distance between aggregates. The result of the repulsion causes a transition between phases (mesophase): spherical micelles → cubic phase, rod micelles → hexagonal, and disk micelles → lamellar phase, as shown in Figure 13.³⁶ The schematic also shows the trend in the size of head groups and curvature of each phase going from highest to lowest. These aggregate shapes are known as liquid crystals and have been found to improve the stability, moisture retention, controlled release of active, and the ability to encapsulate targeted molecules, in particularly, those in the lamellar phase.⁹

H. Lyotropic Liquid Crystals

A lyotropic liquid crystal (LLC) is a liquid crystalline state that carries a sense of fluidity while maintaining some structural uniformity.³²

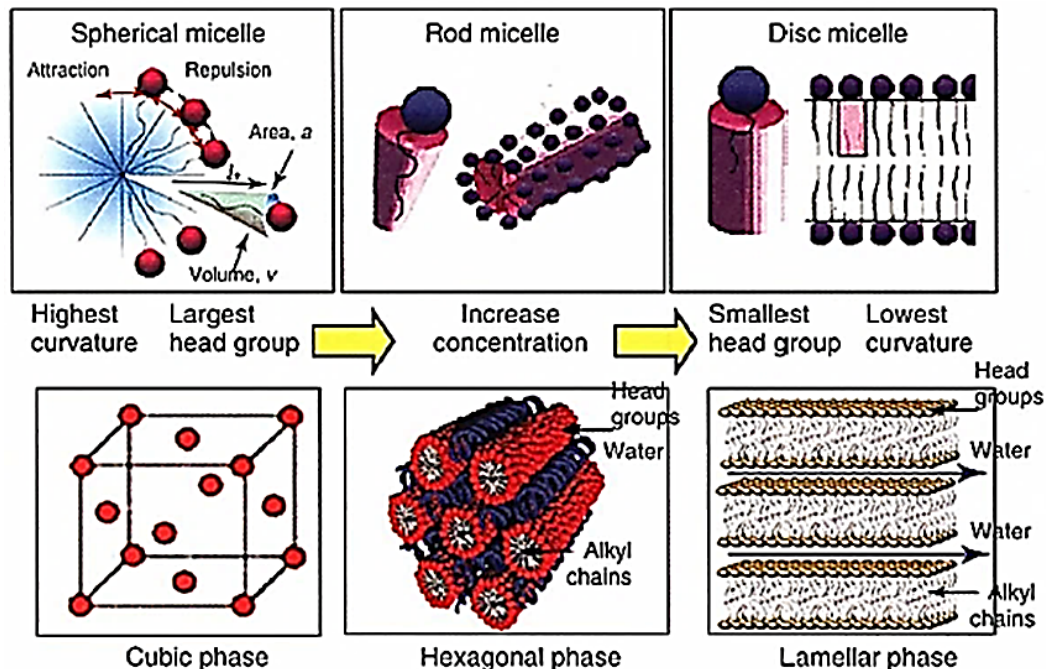

Figure 13. Schematic representation of the mesophases that can occur with an increase in surfactant concentration. Reproduced from Ref. 36

The internal structure of an LLC is composed of hydrophilic and hydrophobic domains, and a lipid bilayer. Due to these characteristic domains LCs have been found to encapsulate a variety of amphiphilic, hydrophilic, and hydrophobic active ingredients, which can protect APIs from hydrolysis and enzymolysis.³⁷

The term *lyotropic* defines a material that forms a crystalline phase upon the addition of a solvent. Before a lyotropic liquid crystalline phase can form, a few interactions take place, and the role of the solvent is realized. Water is often considered an exceptional solvent due to its polarity and inter-molecular hydrogen bonding. The hydrogen bonding between water molecules allows for a vast number of configurations. The possible range of structures allows for a large amount of free volume between neighboring water molecules.³¹ The structures of LLCs depend on a variety of parameters: pH, temperature, light, magnetic field, water content, additives, and

the type of amphiphile.³⁷ In this study the effects of pH and temperature on the formation of LLCs are assessed.

Critical Packing Parameter. There is some predictability and accuracy in determining the kinds of possible structures formed which is possible if the structures geometrical shape and background are clarified. These parameters can then be applied to a ratio rule, also known as the critical packing parameter (CPP), to accurately predict the structures formation. This is an important concept in determining principal structures that can be formed (*e.g.*, micelles and lyotropic liquid crystals) in solution. The CPP can be defined numerically as $CPP = v/al$, where v represents the real volume of the hydrophobic chain, a represents the cross-sectional area of the hydrophilic head group (+ $\frac{1}{2}$ distance to its closest neighbor), and l represents the approximate length of the hydrocarbon in its molten state (Figure 14).³⁸

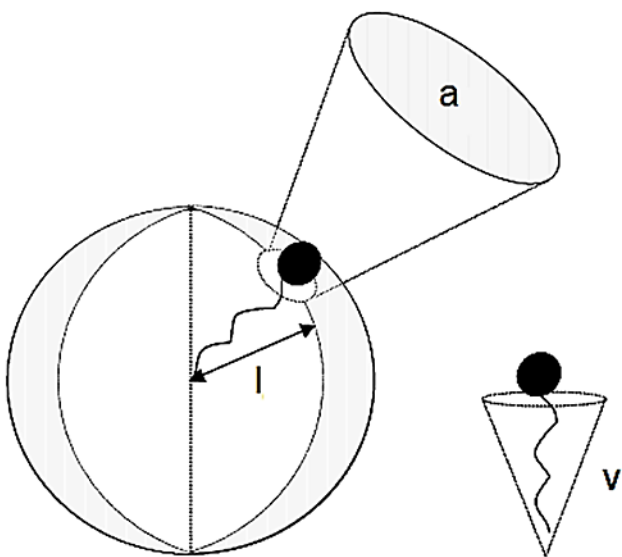





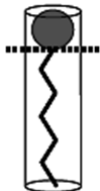
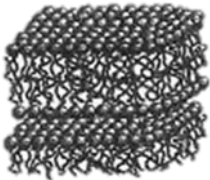



Figure 14. Geometric representation of a surfactant monomer utilized in the CPP calculation. This allows for some predictability and accuracy when determining the formation of aggregates. Reproduced from Ref. 38.

The geometric measurements utilized in the CPP formula produce a ratio value determining the structures shape (Table 5). To relate the CPP to this study, a system containing water and a long-chain alcohol of an ionic surfactant three structures form consecutively. At first, the ionic surfactant forms spherical micelles (CPP value is $< \frac{1}{3}$) in the aqueous solution. This structure is expected due to the repulsive forces between the polar groups of the ionic surfactant, and as a consequence a large a value in the CPP ratio.^{31,38} With a long-chain alcohol and an ionic surfactant lamellar packing is favored. This is a result of the OH group of the alcohol and the charged group of the surfactant. The OH group has no repulsion to the charged groups of the surfactant and will fit into the space between them.^{31,38} This results in a large reduction of the a value, no reduction of v , producing CPP $\frac{1}{2} \leftrightarrow 1$. Continuing the addition of an ionic surfactant and long-chain alcohol results in the continued reduction of the a value and inverse phases of LLCs occur.^{31,38}

Improved Moisture Retention by LLCs. Zhang and Liu⁹ theorized the improved stability and moisture retention with the formation and the increased volume percent of LLCs in an O/W emulsion. Moisture retention, relative to this study, can be defined as the final quantity of condensed water diffusing across the SC. They also investigated the water content (*i.e.*, hydration) of the cells before and after the application of the emulsion. Each study applied emulsions containing different percent volume of LLCs (*e.g.*, 2%, 4%, 6%, and 8%) to the skin to measure its moisture retention and hydration via a Transepidermal Water Loss (TEWL) and a corneometer. A corneometer was used to measure the hydration level of the SC via dielectric properties by passing an electric field through the SC and measuring the water content within the skin cells.³⁹ The TEWL measured the moisture retention by quantifying the amount of condensed water diffusing across the surface of the SC per unit of time.⁴⁰

Table 5. Changes in the critical packing parameter. Adapted from Ref. 32,39.

R-value	Name	Surfactant Type	Shape	Structure Formed
$< \frac{1}{3}$	Spherical aqueous micelle	Single-chain with large head group		
$\frac{1}{3} \leftrightarrow \frac{1}{2}$	Cylindrical or Rod-shaped micelle	Single-chain with small head groups, or ionic with electrolytes present		
$\frac{1}{2} \leftrightarrow 1$	Vesicles and Flexible bilayers (Lamellae)	Double-chain with large head group, flexible chain		
1	Planar bilayers	Double-chain small or rigid head group, immobile chain		
> 1	Inverse cylinder or micelle	Double-chain with small head group, bulky hydrophobic groups		

It was found that no change in the hydration level of the cells in the SC occurred over time. However, the moisture retention of the SC improved as the percent volume of LLCs increased in the emulsion. This would suggest that the improved moisture retention properties of the emulsion could be due to LLCs ability to entrap water molecules within the ordered structure of the LLC by interacting with the hydrophilic portions of the surfactant molecules.⁹

Improved Emulsion Stability by LLCs. The Crodafos CES surfactant used in this study is known to form multilayered LLCs that surround oil droplets providing stability to coalescence (*i.e.*, oleosomes) (Figure 15).⁴¹ The remainder of the LLCs produce a network that form throughout the continuous phase (*i.e.*, hydrosomes), which exhibits viscoelastic behavior.⁴¹ The oleosomes formed can be observed visually under polarized light microscopy as ‘Maltese Crosses’.^{7,38,42}

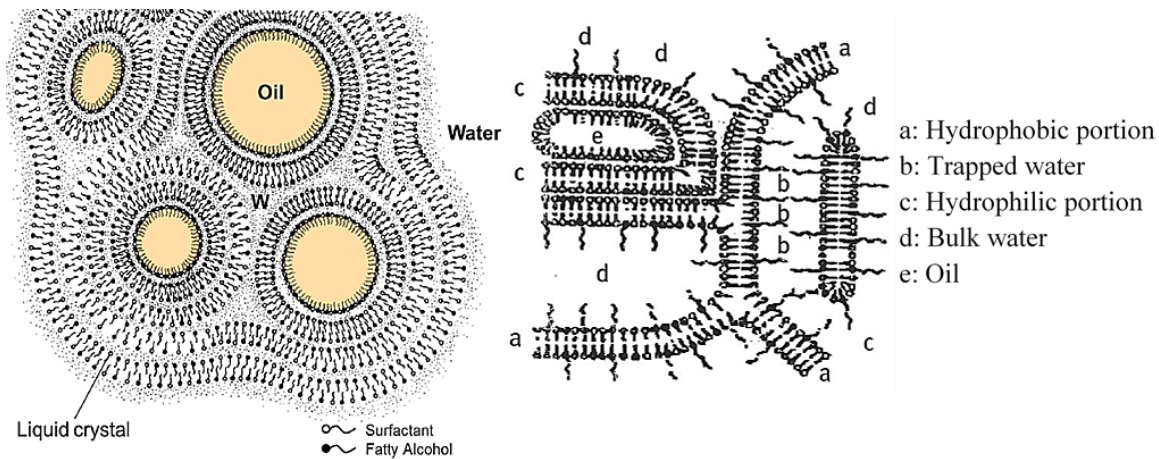

Figure 15. Schematic representation of an oleosome (left) and a hydrosome (right). Reproduced from Ref. 7, 38.

Friberg and co-workers⁴³ completed a study showing that the formation of LLC multilayers around oil droplets at the O/W interface reduces the chance for flocculation and later coalescence. The LLC multilayers act as a protective barrier between two oil droplets which

lessen the van der Waal attraction potential and ultimately improve the overall stability of the emulsion. Figure 16 shows a schematic that illustrates an uncovered droplet versus a multilayered LLC-covered droplet. When comparing an uncovered droplet going into the flocculation step $A_n \rightarrow F$ and an LLC-covered droplet going into the flocculation step $A_c \rightarrow M_c$, it can be seen that several monolayers from the LLC-covered droplet would need to be removed before flocculation could occur. The presence of the LLC reduces the potential drop by absorbing almost all of the potential energy available ($\sim 75\%$) to reach the common state F prior to step $A_c \rightarrow M_c$ (Figure 17). Only ($\sim 25\%$) of the potential energy is available for coalescence to occur $M_c \rightarrow F$ compared to an uncovered droplet which has 99.7% of the potential energy available for thinning of the viscous film. The LLC surrounding the oil droplet has a higher viscosity than for the oil itself which further enhances the emulsions overall stability.⁴³

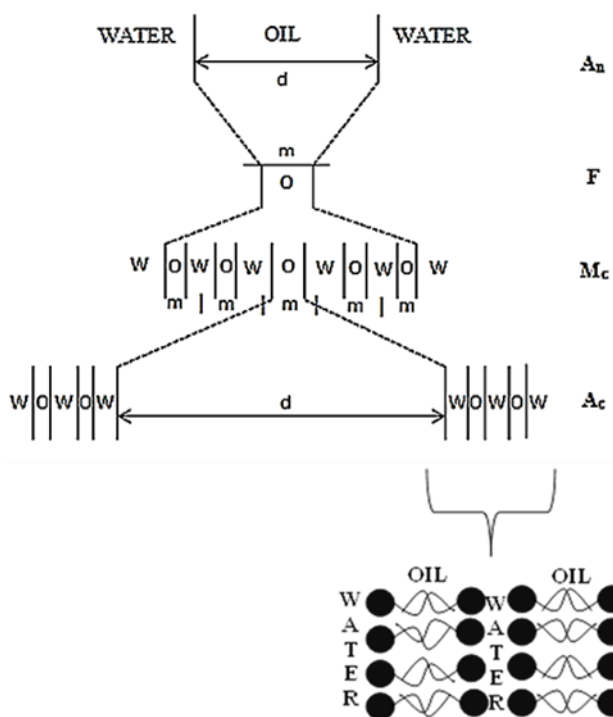

Figure 16. Uncovered vs LLC-covered oil droplets. O = oil, W = water, | m | = monolayer, d = distance between droplets. Adapted from Ref. 43.

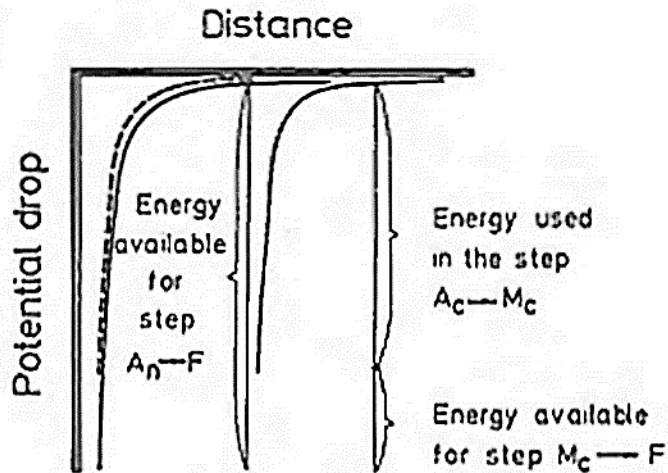

Figure 17. The solid lines represent the distance between uncovered droplets surfaces. The dotted line represents the distance between LLC-covered droplets. Adapted from Ref. 43.

Microscopic View. Microscopic View is a term designated by the Food and Drug Administration (FDA) to describe using polarized light microscopy (PLM) to determine API particle size and bright-field microscopy (BFM) to determine globule size. Microscopic View provides a rapid and accurate analysis of a topical product without the use of chemical analysis and is required by the FDA if the product is an emulsion. It is also recommended when globule size or API particle size is a Q3-critical quality attribute (CQA) of the active product (*i.e.*, an attribute that corresponds to an appropriate range and equivalent microstructure to ensure an equivalent product).⁴⁴

Polarized Light Microscopy. PLM can determine the presence of birefringent material due to the material's anisotropic properties. Anisotropic materials (*e.g.*, lamellar LLC) contain two different refractive indices, an ordinary and extraordinary ray (Figure 18). This inequality of refractive indices is due to the difference in characteristics between the grain boundaries of the crystal. The greater the difference between the refractive indices generates an increase in scattering of the transmitting light which causes a decrease in transparency of the material (*i.e.*,

rise in opaqueness). This analysis is achieved by utilizing a microscope fitted with a polarizer and analyzer as seen in Figure 19.

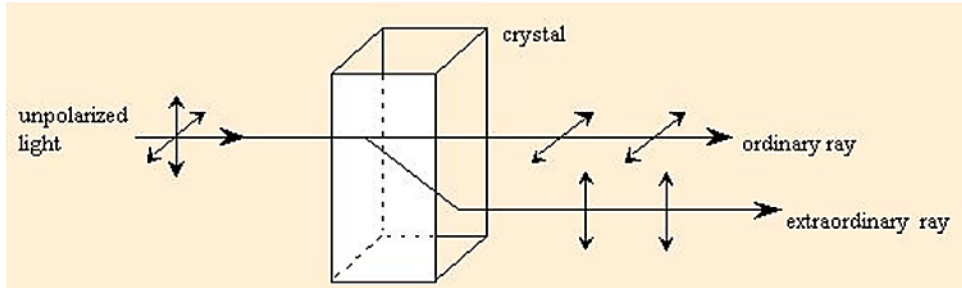

Figure 18. Schematic representation of unpolarized light going through a birefringent material that creates two refractive indices, ordinary and extraordinary. Reproduced from Ref. 45.

The light source from the microscope will pass through the polarizer, creating polarized light. The polarized light goes through the birefringent material, which produces the ordinary and extraordinary indices (Figure 18). The analyzer then recombines the two indices creating a colorful representation of the birefringent material.⁴⁴

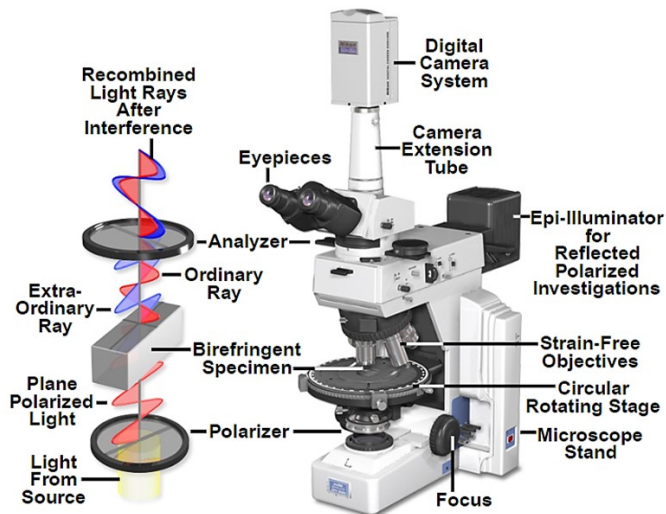

Figure 19. Schematic representation of a trinocular polarized light microscope fitted with a digital camera. Adapted from Ref. 44.

Maltese Cross. The molecular structure that forms the LLC determines the structure's electric responsiveness (*i.e.*, birefringence). This response is distributed throughout the structure and affects its polarized image.⁴⁵ If the structure is defined as anisotropic then its electric responsiveness is caused by the elongated monomers (*e.g.*, surfactants) oriented in the LLC.⁴⁶ The elongated monomers create a dipole moment from the electric waves vibrating parallel and perpendicular (*i.e.*, ordinary, and extraordinary indices, respectively) to the plane of the molecule. The wave vibrating parallel to the elongated monomer is much larger than the perpendicular wave, which causes the LLC to be birefringent.⁴⁶

Bellare and co-workers⁴⁶ defined how the image created by a lamellar structure is created based on the surfactant molecules' electric responsiveness. The surfactants that make-up the lamellar structure organize as a homogeneous disk of a specific thickness. When the disk is perpendicular to both the polarizer and analyzer its transmitted intensity is maximized, while being parallel the intensity is minimized. The dark portions of the lamellae are due to molecules being parallel to the polarizer or analyzer directions (Figure 20). Thus, a 'Maltese cross' image is produced from layers of anisotropic material that are separated by isotropic material,⁴⁶ and an observation of such a feature in a *Microscopic View* experiment is considered to be an indication that lamellar structures are present in an emulsion.⁴²

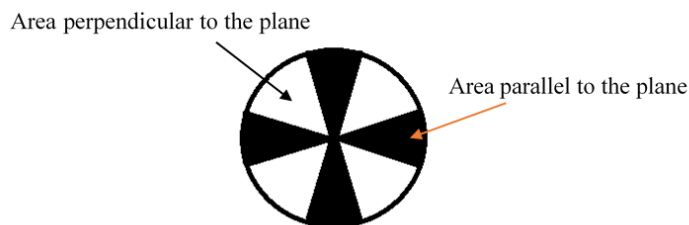

Figure 20. Drawing of a Maltese cross to show the areas of birefringence and isotropy. Redrawn from Ref. 42.

I. Thesis Statement and Purpose

A moisturizing cream containing a high concentration of a novel solvent can be stabilized by the formation of lamellar LLCs. This is determined by incorporating an anionic surfactant that is known to form lamellar LLCs across a wide range of pH values. The physical and chemical stability of this emulsion is determined across a full topical cream pH profile, and its overall character and stability is attributed to the presence and abundance of lamellar LLCs.

CHAPTER II: MATERIALS AND METHODS

A. Materials

Chemicals. Emulsifier: SP CRODAFOS CES MBAL-PA-(MH) mix of ceteth-10 phosphate, dicetyl phosphate, and cetearyl alcohol (C16-18) surfactant from CRODA (Edison, NJ, USA). Emollient: Super refined® Crodamol isopropyl palmitate-IPP-L-Q-(JP) provided by CRODA (Edison, NJ, USA), white petrolatum consumer grade (Springfield, MO, USA). Solvent: Purified water, diethylene glycol monoethyl ether with a trademark name of Transcutol® HP provided by Gattefosse sas (Saint Priest-Cedex, France). Preservative: Methyl 4-hydroxybenzoate 99%, propyl 4-hydroxybenzoate 99+% purchased through Acros Organics (New Jersey, USA). pH adjuster: Aqueous sodium hydroxide, 1.0 molar concentration.

Instruments. Topical creams were mixed using a power control viscosity propeller (IKA Eurostar). Centrifugation was completed by a (Sorvall RC-58) refrigerated superspeed centrifuge using a (5S-34) fixed angle rotor. The pH was analyzed using a (Mettler Toledo) InLab Flex-Micro pH combination electrode. Microscopy was completed using either an (Amscope PZ300) or a generic metallurgical microscope similar to a (Nanjing Jiangnan Optics Co. NJF-120A), both having polarization capabilities. A microspatula was used to spread a small amount of cream onto the glass slide. Micrograph images were recorded by using (ScopeImage 9.0) professional imaging software. Micrograph scales were calibrated by imaging a (USAF 1951) test target. Microscope was used to observe samples heated on a low-profile cooling and heating stage (Bioscience BTC-SL-128x80). The temperature is controlled by a 2-channel temperature controller (Bioscience TC-1-100i) with a self-adjusting stability of 0.01°C and 0.1°C accuracy.

B. Methods

Cream Formulation. Topical creams were formulated using a composition and process provided by Dr. David Osborne (Table 3).⁴ The oil and water phases were mixed in separate 150 mL beakers. The water phase was transferred into a 250 mL Wheaton bottle, and both phases were placed into an oven set at 85°C to bring both phases to a temperature above 70°C. The parabens and DEGREE were measured into a 150 mL beaker and stirred at ambient conditions on a stir plate until complete dissolution of the preservatives. Once the oil and water phases reached a temperature above 70°C the emulsification process began.

The water phase was poured into a 400 mL beaker and measured to verify the amount of water phase utilized in the emulsion. The 400 mL beaker containing the water phase was quickly placed under the viscosity propeller and stirred at 455 rpms. The oil phase was then carefully poured into the water's vortex created by the propeller. The DEGREE and preservatives were then added to the oil/water mixture, and stirring continued until the mixture's internal temperature cooled to 47°C – 49°C. The emulsion was then poured into five 70 mL storage containers and left to sit for 24 – 48 hours before centrifugation.

Centrifugation. After the 24 – 48 hour setting time, 30 g of the emulsion was placed into a 50 mL centrifuge tube and centrifuged at 20,000 rpms (~48,000 g) for 2 hours. After centrifugation the emulsion was separated into two or three phases (Figure 21).⁴⁷ At pH values in the range 2.0 to 5.0, two phases were produced, an aqueous phase and a cream layer, while at pH values in the range 8.0 to 10.0, three phases were produced, aqueous, cream, and oil phases. For all samples, the aqueous phase exhibited the highest density and was found at the bottom of the centrifuge tube, while the oil phase (when present) exhibited the lowest density and was found at the top.

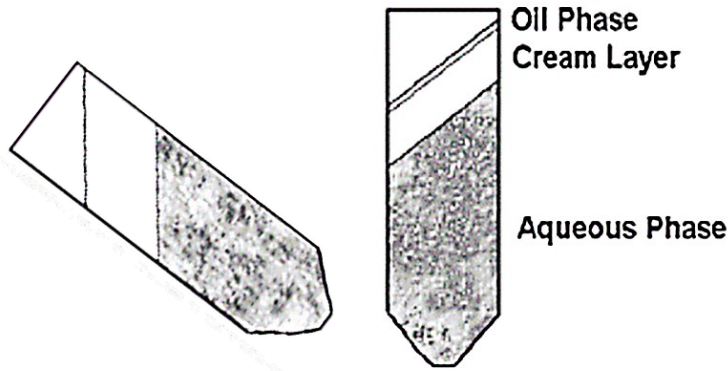

Figure 21. Diagram of the phase separation that occurs during centrifugation. The centrifuge tubes are fitted at an angle into a fixed-angle rotor (left). When the centrifuge tubes are removed from the rotor and set at an upright the phases remain at an angle (right). Adapted from Ref. 47.

Removal of Aqueous Phase. The aqueous phase was removed from below the solid phase by carefully tunneling through the solid phase using a microblade spatula. A glass micropipette was guided down the same path to remove the aqueous phase. The water phase was transferred to a 5 mL beaker, and its mass and pH were measured.

Accelerated Shelf-Life Study. About 20 g of each sample were placed into two separate scintillation tubes to be analyzed for physical stability (*e.g.*, creaming). Of the two scintillation samples, one tube was placed under a fume hood at ambient conditions while the other tube was placed in an oven set at 40°C for accelerated aging studies. The mass and pH values of each sample (ambient and accelerated) were analyzed at 30 days and 60 days.

Microscopy. A small portion of the cream was spread thinly onto the glass slide using a micro spatula. A derm spreader with a center depth of 0.15 mm produced a film too thick for viewing transmission images. Under polarized light microscopy, the birefringence was too blurry due to the multiple layer's birefringence. A glass cover slip was not used to ensure that no mechanical alteration of the lyotropic liquid crystals occurred. The contents on the slide were analyzed under the microscope using polarized light imaging (transmission mode). Each sample

was investigated with objective magnifications of 4x, 10x, and 40x. Combined with the approximately 22x magnification of the digital camera, these objectives corresponded to total magnifications of 88x, 220x, and 880x, respectively. For samples used during the hot stage observation the stage is outfitted onto the viewing base of the microscope. A temperature controller raised the heat of the hot stage to temperature ranges up to 45°C.

CHAPTER III: RESULTS AND DISCUSSION

Ultracentrifugation techniques and accelerated temperature conditions have been described to predict the physical and chemical stabilities of a finished cream, respectively. Just as storage of a cream at 40°C is an accelerated temperature study for its overall chemical stability, centrifugation is an accelerated gravity condition to predict the cream's physical stability. The difficulty to break a cream (*i.e.*, separate the cream into distinct phases) by centrifugation can be used as a measure of the cream's physical stability, while a cream that maintains its pH value through an accelerated shelf-life study is said to indicate chemical stability.⁴⁸

PLM has been employed to detect birefringence in the emulsions at variable pH values. Birefringent patterns show that the Crodafos CES emulsions have anisotropic properties over the entire pH profile. Not all LLCs exhibit birefringence. Those that do are hexagonal and lamellar microstructures, and both are easily discernable under PLM.

A. Physical and Chemical Stability

Formulating with an emulsifier that forms stable creams over the pH range 2.0 – 10.0 potentially provides advantages for pharmaceutical applications. As seen in Figure 22, increasing amounts of 1.0-N NaOH gradually raises the creams pH to a value of 5.50. An inflection point occurs between pH values 5.50 – 7.50, before returning to gradually increasing pH up to pH = 9.00. Regarding the pH values, the inflection point corresponds to the neutralization of the alkyl phosphate surfactants (*i.e.*, dicetyl phosphate and ceteth-10 phosphate) contained in the waxy blend Crodafos CES. A pH value selected in the inflection point will make it difficult to target a

specific cream pH value. The relatively small amounts of NaOH added could result in half unit swings in the pH of the finished product.

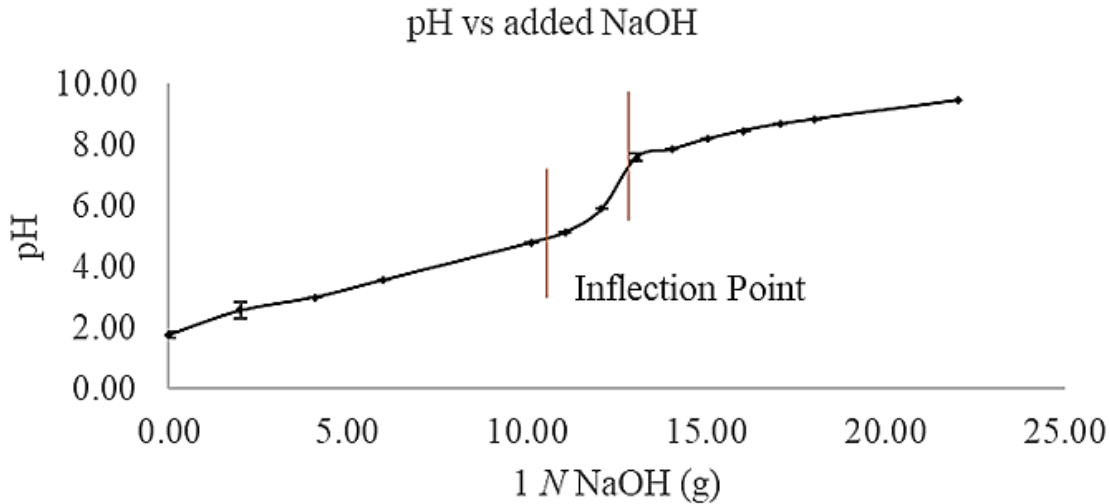

Figure 22. The range between 3.50 and 9.00 is of most value to this formulation. Inflection point pH range is 5.50 – 7.50. Representative error bars shown on select data points were determined by replicate experiments.

Figure 23 compares the pH values of the separated water phase of the creams for both ambient and accelerated (40°C) storage conditions at initial, 30-day, and 60-day. The data from Figure 22 is tabulated in Table 6. No trends were identified for changes in the pH value upon storage at either ambient or accelerated conditions. Some inherent variability in the pH values can be seen in the data, but in general the before and after storage conditions agreed to within a range of +/- 0.2, indicating chemical stability over a decent temperature range.

The mass of the aqueous phase obtained after centrifugation suggested a presence of a pH dependence in the physical stability of the cream. For pH values below the inflection (pH < 6.00), the emulsion is more difficult to break, as indicated by the decrease volume of the separated aqueous phase. A decrease in aqueous phase mass after 2 months storage of creams across the pH

profile is consistent with an increase in emulsion structure upon storage, at both ambient and accelerated conditions. As the pH value of each cream increased across the profile the separated aqueous phase mass increased, which indicated a less stable emulsion.

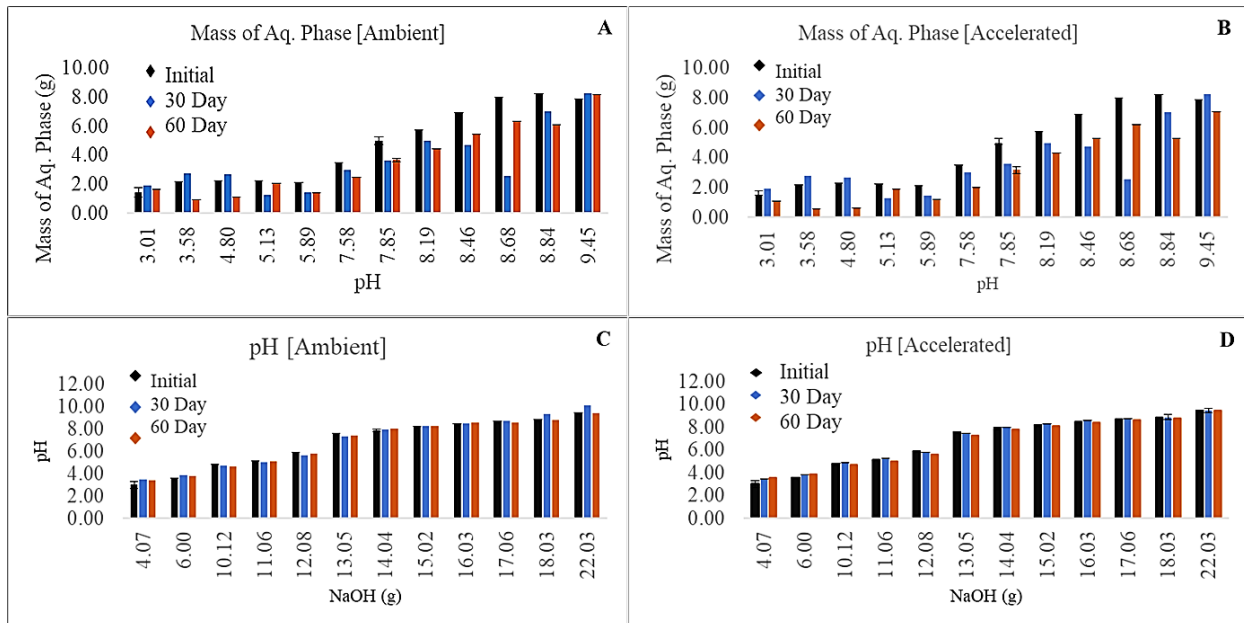

Figure 23. Plots A and B compare the mass of aqueous phase obtained after centrifugation under ambient and accelerated conditions, respectively. Plots C and D compare the pH values of the extracted aqueous phases under both ambient and accelerated conditions, respectively. Error bars were determined for select samples by replication.

The instability in creams containing higher pH values corresponds to the increase effective size of the hydrophilic head of the surfactant. The larger head group is caused by the neutralization of phosphate groups by the Na^+ ions increasing its effective size ratio (*i.e.*, CPP) compared to its hydrophobic tail. The increased ratio between the head and tail of the surfactant decreases its attractive force to the O/W interface. This creates instability in the emulsion, which is apparent in the increased mass of the removed aqueous phase as the increased volume of NaOH. As mentioned above, the CPP ratio determines the spatial packing of the surfactant molecules (*e.g.*, lamellar LCs).

Table 6. Tabulated data from Figure 23.

1.0-N NaOH added (g)	Initial pH	pH 30-day Ambient	pH 30-day (40°C)	pH 60-day Ambient	pH 60-day (40°C)
4.072	3.01	3.50	3.46	3.43	3.53
6.002	3.58	3.84	3.86	3.76	3.87
10.12	4.80	4.74	4.92	4.66	4.73
11.06	5.13	5.05	5.23	5.10	5.02
12.08	5.89	5.62	5.77	5.80	5.62
13.05	7.58	7.37	7.43	7.43	7.23
14.04	7.85	7.93	7.97	7.99	7.82
15.02	8.19	8.26	8.30	8.27	8.10
16.03	8.46	8.50	8.57	8.58	8.38
17.06	8.68	8.71	8.76	8.60	8.60
18.03	8.84	9.35	8.86	8.79	8.80
22.03	9.45	10.10	9.45	9.40	9.43

B. PLM Micrograph

When a LC stabilized emulsion is viewed under PLM, the image will contain a pattern of birefringence. The birefringence results from the unique structure of the LC in the emulsion having a diversity of orientations. The PLM images in Figure 23 are shown for pH values 4.80, 5.89, and 8.19. The birefringence patterns found in the images show the Crodafos CES emulsions are anisotropic creams at ambient conditions across the entire pH range. A characteristic pattern for lamellar LLCs, also known as “Maltese Cross”, were observed for pH values below pH 8.19 (Figure 24).

As NaOH is added to bring the pH to the inflection point (pH 5.89) the birefringent material, while mostly remaining lamellar, become less abundant and more inhomogeneous.

When a sufficient amount of NaOH solution has been added to the emulsion to bring the pH value above the inflection point, the appearance of the birefringence material becomes even more inhomogeneous and indicates a shift in stability (pH 8.10).

The abundance, and homogeneity of the lamellar structure is observed to have a pH dependence. Below the inflection point the phosphate surfactant is in its acidic form, and here we see an increase in birefringence and strong lamellar structure. Above the inflection point the phosphate surfactant is in its base form. In the basic environment the lamellar structure is weak and clustered together causing a decrease homogeneity of LLCs in the emulsion. Inside the inflection point the now neutralized ionic surfactant struggles in creating lamellar LLCs which is apparent in the limited amount of birefringence seen under crossed polarization.

C. Thermal Study

An emulsion sample from below the inflection point, pH 4.80, was placed onto a low-profile heating and cooling hot stage to observe the changes in the structure and presence of LLCs in the emulsion. Images were taken as the emulsion was heated to 44.6°C and cooled to 24.8°C (Figure 25). This pH value was chosen due to the abundance of lamellar LLCs presence in the emulsion.

The appearance and abundance of lamellar LLC's decreased as the temperature slowly increased. When the temperature reached to 44.6 °C some birefringence could still be seen, but most of the image turned isotropic, and the characteristic Maltese cross features were no longer observed. As the sample slowly cooled back toward room temperature the birefringence slowly reappeared. Some Maltese cross features can be seen in the final cooled image (Image F).

However, they are not equivalent to those observed before heating (Image A). One important

result from the thermal experiment is that although the lamellar LLC structure appears to disappear at raised temperatures, the intensity of the birefringence is reversible upon cooling. The reversibility of the intensity could indicate that a morphology did not occur, but rather the alkyl alignment became more fluid which decreased its intensity. The characteristic structure was difficult to locate as well. As the lamellar LLCs were heated then cooled it is possible the stacked bilayers went from symmetric to asymmetric resulting in an altered birefringent observation.⁴⁹

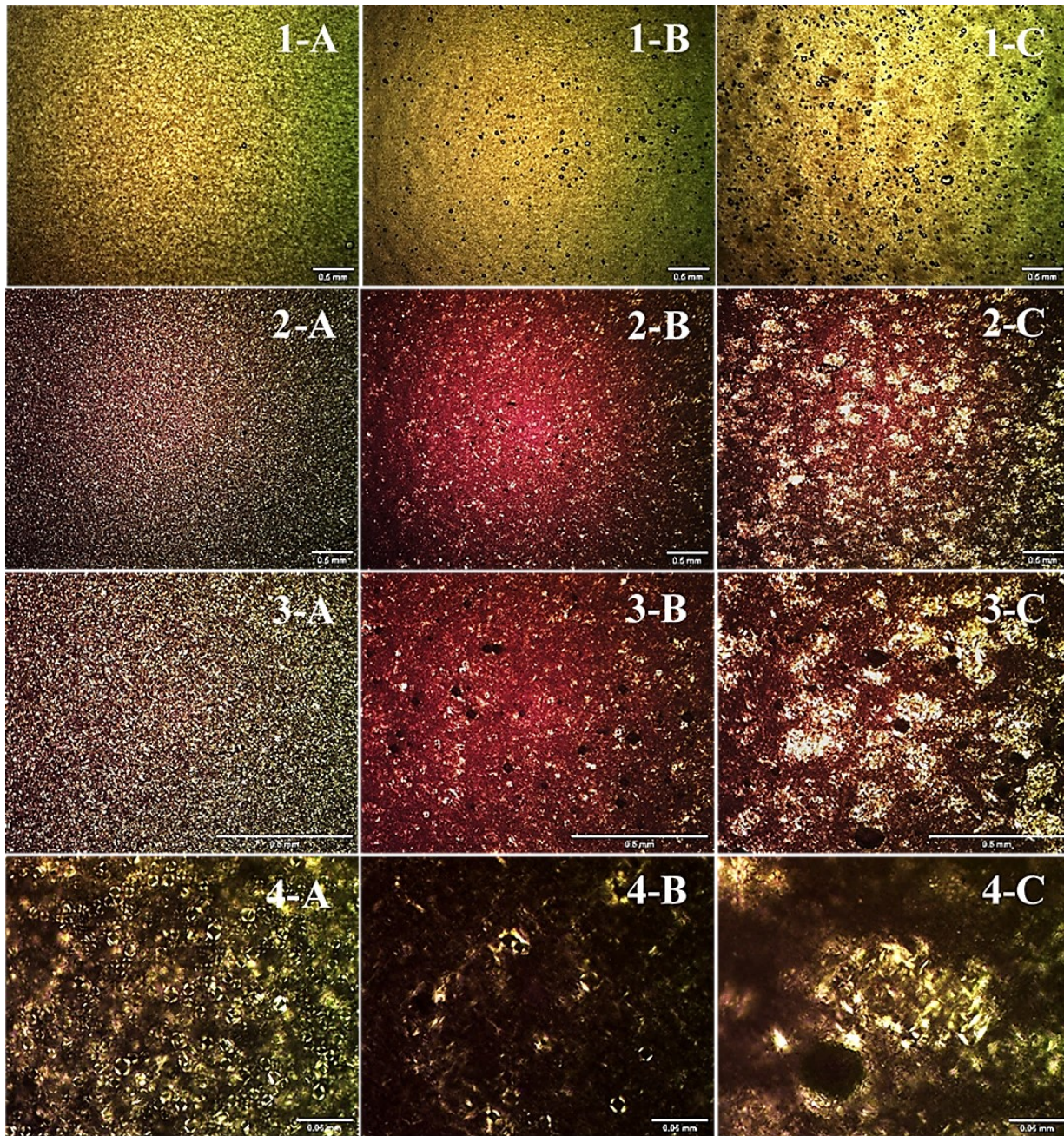

Figure 24. Microscope images of three emulsions with varied pH values: pH 4.80 (column A), pH 5.89 (column B), and pH 8.19 (column C). Images in row 1 are viewed under bright field illumination. Magnification: row 1, 88x; row 2, 88x; row 3, 220x, row 4, 880x.

Heating

Cooling

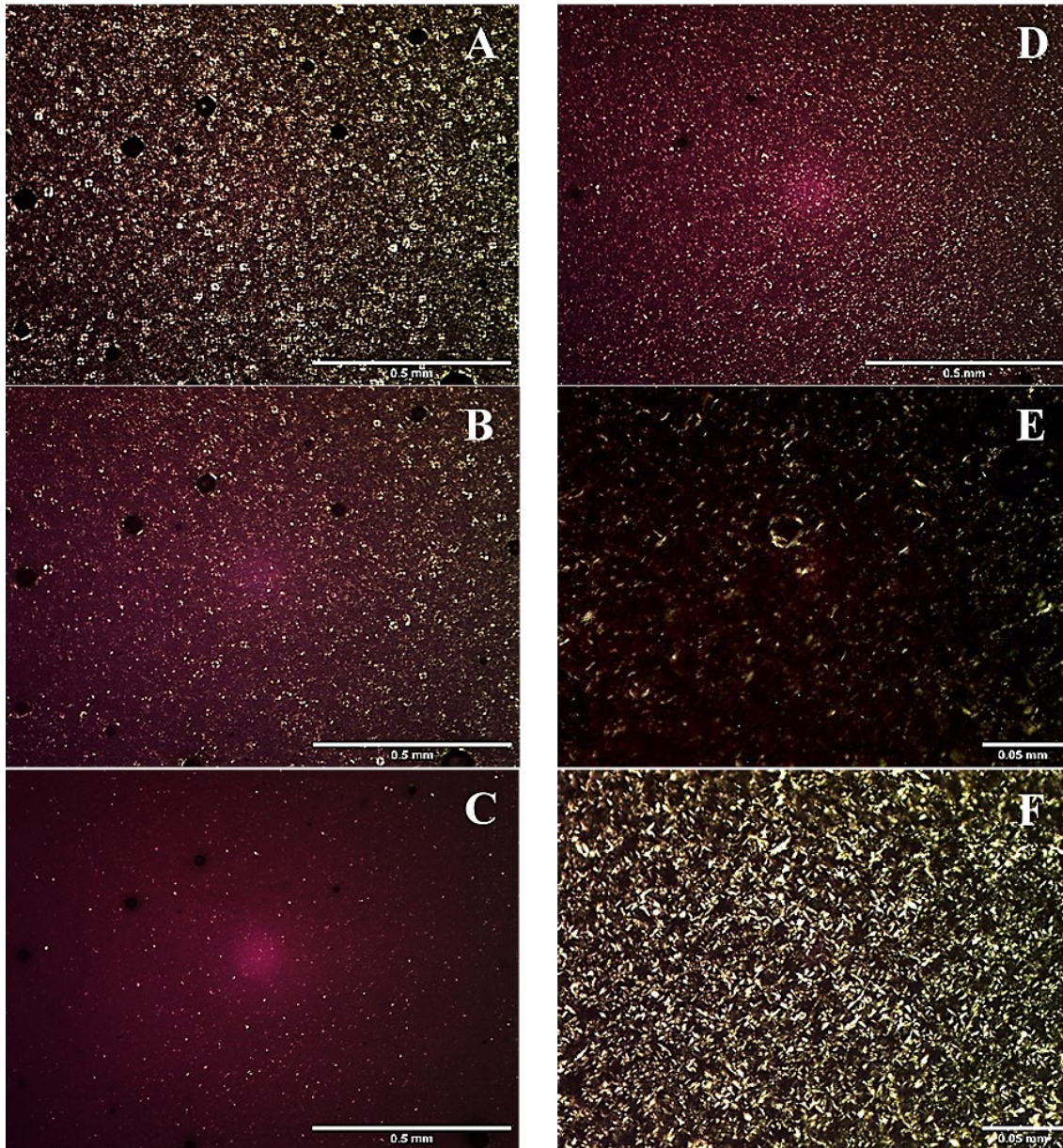

Figure 25. Micrographs of an emulsion sample with a pH of 4.80. A) 220x mag. at ambient conditions, B) 220x at 34.7°C, C) 220x at 44.6°C, D) 220x after cooling to 26.8°C, E) 880x at 26.2°C, and F) 880x cooled to 24.8°C. Image E is 880x magnification of image D, and while changing objective the temperature dropped from 26.8°C – 26.2°C.

CHAPTER IV: CONCLUSION AND FUTURE PROSPECTS

The addition of the emulsifying wax blend (Crodafos CES) forms a lamellar lyotropic liquid crystal stabilized oil-in-water emulsion over a wide pH range 3.50 to 9.00. This moisturizing cream remains physically and chemically stable after two months of storage at (40°C) after incorporation of 25 wt% of DEGEE, indicating a lasting shelf life. The presence of lamellar lyotropic liquid crystals was found to be pH dependent, with their presence decreasing with increasing cream pH. It may be desirable, for the proper production of lamellar LLCs, for the formulator to formulate the emulsion in the phosphate surfactants acid form.

The broad range of pH tunability and presence of lamellar lyotropic liquid crystals provide advantages in formulating creams containing ionizable APIs. As mentioned in the introduction, active pharmaceutical ingredients would need to be non-ionized for diffusion across the skin (stratum corneum); an ionized active pharmaceutical ingredient has a lower permeability coefficient. Thus, controlling the ionization of an active pharmaceutical ingredient can be completed utilizing this formulation.

The thermal study provided interesting results towards the intensity change in the birefringence of lamellar lyotropic liquid crystals in the finished cream. During the thermal study, the once anisotropic cream turned isotropic at elevated temperatures. As the cream cooled to ambient conditions the anisotropic material reappeared, indicating reversibility, which may prove no change in microstructure, but rather a change in alkyl alignment and shifting of the stacked bilayers.

It would be of interest to utilize other instrumentation to truly determine if the isotropic moment during the thermal study had any structural changes versus intensity reduction. Small-

and wide-angle diffraction could be implemented as well as NMR. Applying the thermal study to creams with other pH values may be helpful if a structural change in the crystal structure is a possible outcome. Creams with pH values below 4.80 were not observed vigorously under crossed polarization to determine the abundance and presence of lamellar LLCs. It would be of interest to evaluate all pH values with intent to verify the existence of lamellar LLCs.

REFERENCES

- 1) S. Bjorklund, Q. D. Pham, L. B. Jensen, N. O. Knudsen, L. D. Nielsen, K. Ekelund, T. Ruzgas, J. Engblom, E. Sparr, *J. Colloid Interface Sci.*, **2016**, 79, 207-220.
- 2) A. Ganem-Quintanar, C. Lafforgue, F. Falson-Reig, P. Buri, *Int. J. Pharm.*, **1997**, 147, 165-171.
- 3) R. Gannu, V. Y. Vishnu, V. Kishan, Y. Madhusudan Rao, *J. Pharm. Sci. Technol.*, **2008**, 62 (4), 256-263.
- 4) M. Manconi, C. Caddeo, C. Sinico, D. Valenti, M. Mostallino, G. Biggio, A. Fadda, *Eur. J. Pharm. Biopharm.*, **2011**, 78, 27-35.
- 5] W. A. Ritschel, R. Panchagnula, K. Stemmer, M. Ashraf, *Skin Pharmacol.*, **1991**, 4, 235-245.
- 6) D. W. Osborne, *J. Cosmet. Dermatol.*, **2011**, 10, 324-329.
- 7) R. Lathrope, D. Osborne, Emulsive composition containing dapsone. US 20130018104 A1, January 17, 2013.
- 8) M. J. Sutton, D. W. Osborne, K. Dahl, V. Bax, A. G. Schick, *J. Cosmet. Dermatol. Sci. Appl.*, **2018**, 8, 207-217.
- 9) W. Zhang, *J. Cosmet. Dermatol. Sci. Appl.*, **2013**, 3, 139-144.
- 10) M. Geerligs, *Skin Layer Mechanics*, Ph.D. Dissertation, Eindhoven University of Technology, Eindhoven, **2010**.
- 11) C. Vitorino, J. Sousa, A. Pais, *Curr. Pharm. Des.*, **2015**, 21, 1-15.
- 12) J. V. Smeden, M. Janssens, G. S. Gooris, J. A. Bouwstra, *Acta Biochim. Biophys.*, **2014**, 1841, 295-313.
- 13) H. Trommer, R. H. H. Neubert, *Skin Pharmacol. Skin Physiol.*, **2006**, 19, 106-121.
- 14) M. Yazdanian, E. Chen, *Vet. Res. Commun.*, **1995**, 19, 309-319.
- 15) Y. Javadzadeh, K. Adibkia, H. Hamishekar, *Transcutol® (Diethylene Glycol Monoethyl Ether): A Potential Penetration Enhancer: in Percutaneous Penetration Enhancers Chemical Methods in Penetration Enhancement: Modification of the Stratum Corneum*, N. Dragicevic, H. I. Maibach, Eds., Springer: Berlin, **2015**, 195-205.
- 16) B. Steffansen, B. Brodin, C. Nielsen, *Passive Diffusion of Drug Substances: The Concepts of Flux and Permeability: in Molecular Biopharmaceutics: Aspects of Drug*

Characterization, Drug Delivery and Dosage Form Evaluation, Pharmaceutical Press: London, **2010**, 135-151.

- 17) N. Dragicevic, J. P. Atkinson, H. Maibach, *Chemical Penetration Enhancers: Classification and Mode of Action: in Percutaneous Penetration Enhancers Chemical Methods in Penetration Enhancement: Modification of the Stratum Corneum*, N. Dragicevic, H. I. Maibach, Eds., Springer: Berlin, **2015**, 11-27.
- 18) A. C. Williams, B. W. Barry, *Int. J. Pharm.*, **1991**, 74, 157-168.
- 19) D. W. Sullivan Jr., S. Gad, M. Julien, *Food Chem. Toxicol.*, **2014**, 72, 40-50.
- 20) B. D. Hardin, *Toxicol.*, **1983**, 27, 91-102.
- 21) U.S. Food and Drug Administration. Inactive Ingredient Database: Approved Drug Products. <https://www.accessdata.fda.gov/scripts/cder/iig/index.cfm> (accessed Jul 21, 2019).
- 22) F. Levi-Schaffer, N. Dayan, E. Touitou, *Skin Pharmacol.*, **1996**, 9, 53-59.
- 23) A. Otto, J. W. Wiechers, C. L. Kelly, J. Hadgraft, *Skin Pharmacol. Skin Physiol.*, **2008**, 21, 326-334.
- 24) S. E. Friberg, *J. Soc. Cosmet. Chem.*, **1990**, 41, 155-171.
- 25) D. J. McClements, *Soft Matter*, **2012**, 8, 1719-1729.
- 26) T. F. Tadros, *Emulsion Formation, Stability, and Rheology: in Emulsion Formation and Stability*, T. F. Tadros, Ed., Wiley-VCH, Weinheim, Germany, **2013**, (1) 1-73.
- 27) *Emulsion Stability and Testing*, Technical Briefs, Lubrizol Life Science: Cleveland, OH, October **2019**.
- 28) J. Goodwin, *Colloids and Interfaces with Surfactants and Polymers*, Wiley: United Kingdom, **2009**, (2), 76.
- 29) A. Pandey, A. Mittal, N. Chauhan, S. Alam, *J. Mol Pharm. Org. Process Res.*, **2014**, 2 (2), 1-10.
- 30) G. Marti-Mestres, F. Nielloud, *Main Surfactants Used in the Pharmaceutical Field: in Pharmaceutical Emulsions and Suspensions*, Drugs and the Pharmaceutical Sciences Marcel Dekker, New York, **2000**, vol. 105, 1-16.
- 31) J. Eastoe, *Advanced Surfactants and Interfaces: in Surfactant Chemistry*, Advanced Lectures, China Research Institute for Daily Chemical Industry, TaiYuan, China, **2003**, 3-4.

- 32) K. Hiltrop, *Lytropic Liquid Crystals: in Liquid Crystals*; Topics in Physical Chemistry Series, Springer-Verlag, Berlin, Heidelberg, **1994**, vol. 3, 143-171.
- 33) C. V. Kulkarni, W. Wachter, G. Iglesias-Salto, S. Engelskirchen, S. Ahualli, *Phys. Chem. Chem. Phys.*, **2011**, 13, 3004-3021.
- 34) C. Tanford, *The Hydrophobic Effect: Formation of micelles and biological membranes*, John Wiley & Sons, **1980**, (2).
- 35) D. Myers, *Surfaces, Interfaces, and Colloids: Principles and Applications, Ed.*, VCH: New York, **1991**, 299-332.
- 36) A. Alfutimie, R. Curtis, G. J. T. Tiddy, *Lytropic Surfactant Lipid Crystals: Micellar Systems: in Handbook of Liquid Crystals*, J. W. Goodby, P. J. Collings, T. Kato, C. Tschierske, H. F. Gleeson, P. Raynes, Eds., Wiley-VCH, Weinheim, Germany, **2014**, vol. 6, 377-420.
- 37) Y. Huang, S. Gui, *RCS Adv.* **2018**, 8, 6978-6987.
- 38) T. F. Tadros, *Formulations in Cosmetic and Personal Care*, De Gruyter, Berlin, Germany, **2016**, 77-87.
- 39) Corneometer CM 825 – The World’s Most Used Skin Hydration Instrument, Technical Briefs, Courage + Khazaka electronic, Koln, Germany, October **2020**.
- 40) H. Alexander, S. Brown, S. Danby, C. Flohr, *J. Inv. Dermatol.*, **2018**, 138 (11), 2295-2300.
- 41) Croda Health Care Product Finder. https://www.crodahealthcare.com/en-gb/products-and-applications/product-finder/product/96/Crodafos_1_CES#tab-collapse-details (accessed March 23, 2021).
<https://www.ulprospector.com/en/na/PersonalCare/Detail/134/130780/Crodafos-CES>
- 42) O. O. Mykhaylyk, N. J. Warren, A. J. Parnell, G. Pfeifer, J. Laeuger, *J. Polym. Sci. B Polym. Phys.*, **2016**, 54, 2151-2170.
- 43) S. Friberg, K. Larsson, *Liquid Crystals and Emulsions: in Advances in Liquid Crystals*, S. Friberg, Ed., Academic Press, New York, **1976**, vol. 2, 173-197.
- 44) P. Simamora, FDA Public Workshop on the Topical Dermatological Generic Drug Products: Overcoming Barriers to Development and Improving Patient Access, U.S. Food and Drug Administration Online) October 20, **2017**, where Microscopic View is a term acceptable to the Food and Drug Administration to describe using bright-field optical microscopy to determine globule size or polarized light microscopy for determining drug particle size for multi-phasic semisolid products. Microscopic View testing is recommended when globule size or drug particle size is a Q3-critical quality attribute of the drug product.

<https://www.fda.gov/downloads/drugs/newsevents/ucm591915.pdf> (accessed May 9, 2019)

- 45) Nikon MicroscopyU. Polarized light microscopy.
<https://www.microscopyu.com/techniques/polarized-light/polarized-light-microscopy>.
(accessed May 1, 2019).
- 46) J. R. Bellare, H. T. Davis, W. G. Miller, L. E. Scriven, *J. Colloid Interface Sci.* **1990**, *136* (2), 305-326.
- 47) C. Wabel, Ph.D. Dissertation, University of Erlangen, **1998**.
- 48) E. D. Garrett, *J. Pharm. Sci.* **1962**, *51*, 35-42.
- 49) T. Haller, A. Cerrada, K. Pfaller, P. Braubach, E. Felder, *J. Biomem.* **2018**, *1860*, 1152-1161.